

LEDVANCE.LAT



**LUMINARIAS, COMPONENTES
ELECTRÓNICOS, LÁMPARAS LED**
SEPTIEMBRE 2021

Licencia de producto de marca OSRAM
para lámparas en iluminación general



ARQUITECTURA DE MARCA

EMPRESA:  **LEDVANCE**

MARCAS:  **LEDVANCE**

OSRAM 

PRODUCTOS: 

Luminarias LED
y productos innovadores



Lámparas LED

CONOZCA LEDVANCE

Somos uno de los principales proveedores de iluminación del mundo para profesionales y consumidores finales.

LEDVANCE ha surgido del negocio de iluminación de OSRAM y ofrece una amplia gama de luminarias LED para diversas áreas de aplicación, uno de los mayores portafolios de lámparas LED del sector, además de productos para la iluminación tradicional.

SOMOS LEDVANCE

Nuestro nombre combina el origen de la compañía con la visión de redefinir el rol de la luz en el mundo.

LED hace referencia a la iluminación como nuestro negocio principal y expresa la creciente importancia de los productos LED en nuestra compañía.

ADVANCE representa la ambición de nuestra compañía de ser una fuerza impulsora en la industria de la iluminación, pero también más allá.

El logotipo LEDVANCE es representado por un pulso de luz, que ilustra el avance y dinamismo de la empresa, traemos la luz a la vida de las personas.

LÁMPARAS OSRAM

Derivado a un acuerdo con OSRAM, LEDVANCE seguirá comercializando la marca OSRAM para la línea de lámparas tradicionales y LED.

Más información se puede encontrar en el sitio:
www.ledvance.lat

LEDVANCE: AVANZANDO CON LA LUZ

**¿BUSCAS ILUMINACIÓN DE CALIDAD?
CÁMBIATE A LEDVANCE.**

Como un socio confiable para productos de iluminación general, luchamos contra productos de mala calidad en todo lo que hacemos. En LEDVANCE, combinamos la iluminación tradicional en general con tecnologías innovadoras, construimos relaciones duraderas con los clientes y una fuerte red de distribución de nuestros productos.

En todo el mundo somos especialistas en iluminación, en nuevas tecnologías y cambiamos para satisfacer las necesidades del mercado. Estamos presentes en más de 140 países, atendiendo demandas específicas y ayudando a clientes con nuestro equipo de expertos. Nuestra cartera de luminarias cubre todas las aplicaciones profesionales y residenciales.

Para concientizar a los consumidores sobre los productos de baja calidad disponibles en el mercado y posicionar a LEDVANCE como una marca nueva y fuerte, estamos lanzando la campaña "UNA MALA ILUMINACIÓN ARRUINA TU DÍA".

La campaña hace alusión a los problemas que los productos de mala calidad ocasionan en proyectos de iluminación, y sugiere la marca LEDVANCE, que siempre ofrecerá un producto de calidad, de fácil instalación y de excelente costo-beneficio. Para atraer la atención del público, se vale de imágenes fuertes, de excelente calidad escenográfica, con leve toque de humor.



EXPERIMENTA UNA NUEVA LUZ

PRESENTE EN MÁS DE 140 PAÍSES.

Europa, Estados Unidos y Canadá,
Asia y Región Pacífica,
América Latina, África y Medio Oriente.

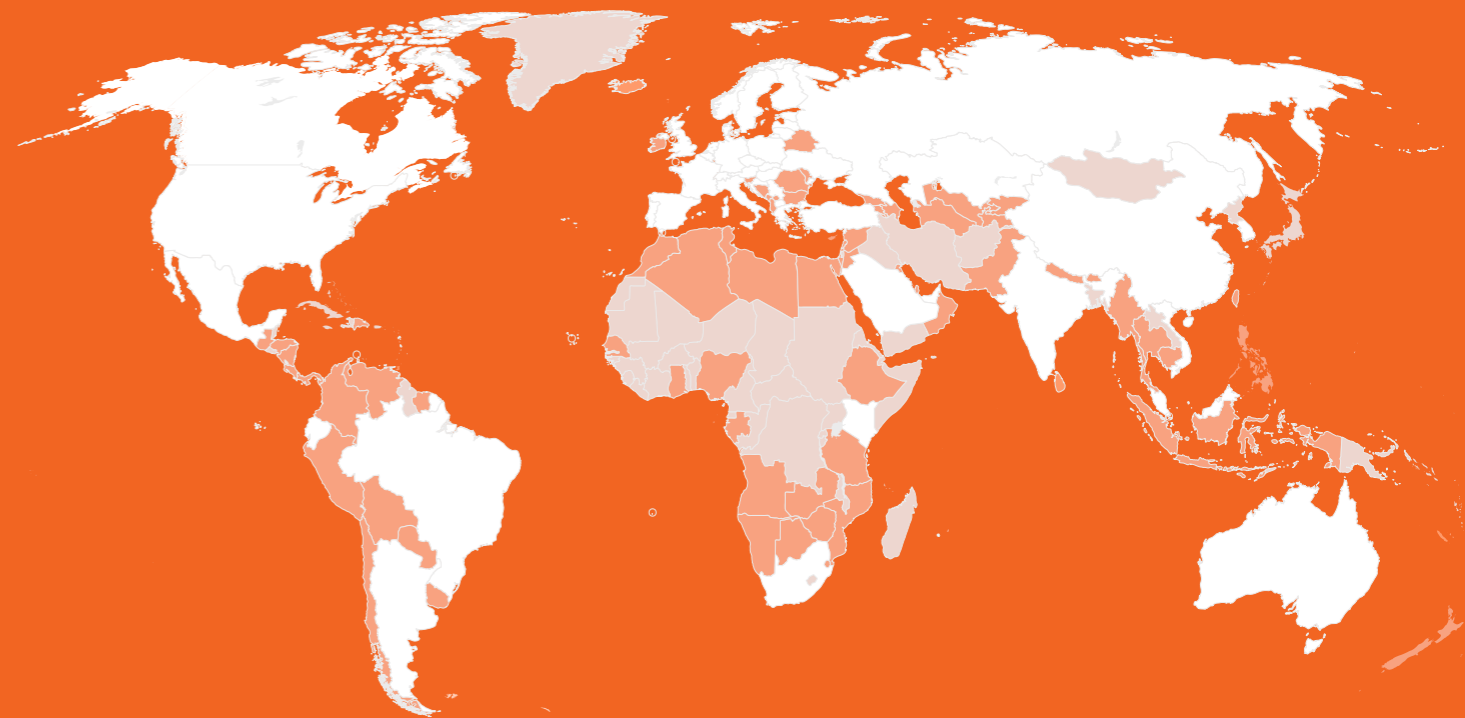

ILUMINACIÓN DE UN COMERCIO MODERNO: ALTOS ESTÁNDARES, DIFERENTES DESAFÍOS

SABIENDO LO QUE IMPORTA...

Los desafíos para planificar la iluminación en espacios comerciales son extremadamente diversos, complejos y diferentes en cada tienda. Detrás de la exitosa iluminación de un comercio hay conocimientos técnicos y experiencia basada en aplicaciones LEDVANCE lo apoya con asesoramiento a medida y soluciones de iluminación modernas.

1. VENTA EFECTIVA



- Presentación atractiva de productos y marca.
- Adaptación óptima del concepto de iluminación a la mercancía y la situación de la tienda, a través de combinaciones personalizadas de iluminación general, de enfoque y efectos.

2. ENCUENTRE SU RECORRIDO



- Diseño de iluminación variada que diferencie el espacio y guíe a los clientes.
- Iluminación de seguridad para casos de emergencia.

4. ALTO CONFORT VISUAL



3. ESCAPARATES

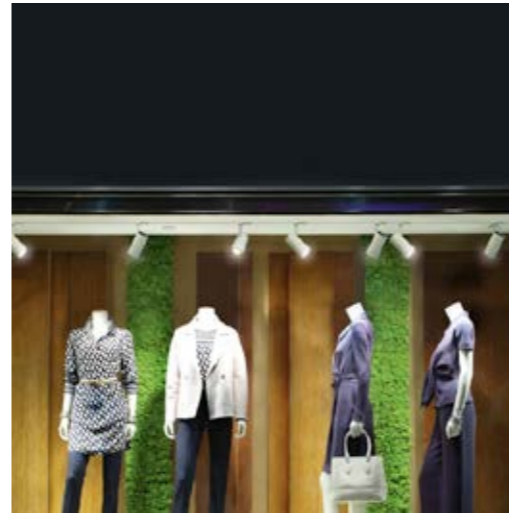

- Crear transparencia a través de altos niveles de iluminación.
- Exhibición con importantes contrastes acentuados con la iluminación.

- Evite el deslumbramiento para clientes y empleados: tomando en cuenta propiedades anti deslumbramiento y posicionamiento correcto de las luminarias.
- Iluminación vertical uniforme para áreas de estantería.

5. PRESENTACIÓN ATRACTIVA



- La excelente reproducción de color (IRC > 90) y la temperatura de color adecuada otorgan un mejor efecto destacando materiales y colores.
- La iluminación de enfoque a través del spot proporciona efectos extraordinarios.

6. GRANDES AHORROS ENERGÉTICOS

- La tecnología LED moderna, duradera y con un manejo de luz inteligente (por ejemplo, a través de sensores de luz y presencia) proporciona alta eficacia energética, bajo mantenimiento y bajos costos de operación.



RESIDENCIAL

PANAN DISC SINGLE	11
DESKLUM	12
SLIM PLAFON	13
FOCOLUM	14
INSERT SQUARE	15
INSERT ROUND	16
LIVIN	17
SMART+ LIGHTING	18



PROFESIONAL / COMERCIAL

PANEL BACKLIT	21
SPOTLIGHT	22
SPOTLIGHT MODULAR	25
DOWNLIGHT	26
DOWNLIGHT PARA BOTE INTEGRAL	27
DOWNLIGHT COMFORT	28
LINEAR	29
LINEAR PENDANT	30
LOWBAY	31
PENDULUM	32
TRACKLIGHT	35
TRACKLIGHT ZOOM	36
MULTISPOT	38
EMERGENCY LIGHT 2X1W	39



INDUSTRIAL

HIGHBAY 220 V	42
HIGHBAY PERFORMANCE	43
FLOODLIGHT HIGH WATTAGE	44
FLOODLIGHT HIGH POWER	45
FLOODLIGHT HIGH POWER 1KW / 1.5KW	46
FLOODLIGHT HIGH POWER 1KW DMX	47
DAMP PROOF HOUSING	48
DAMP PROOF LED	49
DAMP PROOF EMERGENCY	50
DAMP PROOF SENSOR	51
WALL PACK	52



EXTERIOR

SPIKE	55
UPLIGHT	56
WALL LIGHT	58
ENDURA	59
FLOODLIGHT LOW WATTAGE	60
FLOODLIGHT SENSOR PERFORMANCE	61
AREALIGHT	62
URBANA	63



ALUMBRADO PÚBLICO

SKY	66
-----	----



RESIDENCIAL



LEDVANCE® PANAN DISC SINGLE

Luminaria de escritorio que favorecerá al máximo tu rendimiento, concentración y bienestar regulando la intensidad de la luz con su interruptor táctil. Cuenta con una batería recargable que garantiza cuatro horas de libertad inalámbrica, además ofrece conexión directa al puerto USB de la computadora o laptop. Es el compañero ideal en la oficina en casa o rincón de lectura.

Desk lamp that will maximize your performance, concentration and well-being by regulating the intensity of the light with its touch switch. It has a rechargeable battery that guarantees four hours of wireless freedom, also offers direct connection to the USB port of the computer or laptop. It is the ideal companion in the home office or reading corner.



APLICACIONES / APPLICATIONS



Código Sku	Potencia Power (W)	Flujo Luminoso Luminous Flux (lm)	Ángulo de Apertura Opening Angle	Temp. de Color Color Temp. (K)	IRC CRI	Vida Útil Life (h)	Dimensiones Dimensions (mm)	Color de Producto Product Color	Unidades por Caja Units per box
88393	5	220	105°	3000	> 80	30 000	170 x 350 x 370	Blanco	4
88394	5	220	105°	3000	> 80	30 000	170 x 350 x 370	Gris	4



LEDVANCE® DESKLUM

Luminaria de escritorio que se integra perfectamente en cualquier espacio, un complemento ideal para realizar actividades de manera más eficiente, productiva y cómoda. Su diseño ergonómico permite obtener luz precisa para un tipo de actividad en específico, ajustando el brillo o la temperatura de color de acuerdo a las necesidades mediante su botón táctil.

Desk lamp that integrates perfectly into any space, an ideal complement to carry out activities in a more efficient, productive and comfortable way. Its ergonomic design allows to obtain precise light for a specific type of activity, adjusting the brightness or color temperature according to the needs through its touch button.



APLICACIONES / APPLICATIONS



Código Sku	Potencia Power (W)	Flujo Luminoso Luminous Flux (lm)	Ángulo de Apertura Opening Angle	Temp. de Color Color Temp. (K)	IRC CRI	Vida Útil Life (h)	Dimensiones Dimensions (mm)	Color de Producto Product Color	Unidades por Caja Units per box
88444	3	220	90°	2 700 - 6 500	> 80	10 000	286 x 336 x 170	Negro	16
88445	3	220	90°	2 700 - 6 500	> 80	10 000	286 x 336 x 170	Blanco	16

LEDVANCE® SLIM PLAFON

Luminaria de techo para sobreponer o empotrar tipo plafón, con diseño compacto y marco reducido que emite una luz homogénea a través de su difusor. Disponible en versiones redondo y cuadrado en dos temperaturas de color: Luz de Día (6500 K) y Luz Cálida (3000 K). De fácil y rápida instalación.

It is a ceiling luminaire to embed, recessed lighting fixture type. It has an ultrafine design and reduced frame, which emits homogeneous light through its diffuser. Available in round and square versions, at two color temperatures: Day Light (6500 K) and Warm Light (3000 K). Quick and easy to install.

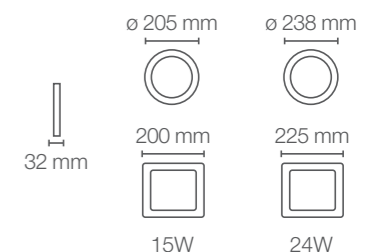

APLICACIONES / APPLICATIONS



Código Sku	Potencia Power (W)	Equivalencia Equivalence CFLI (W)	Flujo Luminoso Luminous Flux (lm)	Ángulo de Apertura Opening Angle	Temp. de Color Color temp. (K)	Vida Útil Life (h)	IRC CRI	Dimensiones Dimensions (mm)	Color de Producto Product Color	Unidades por Caja Units per box
86490	15	2 x 15	1 125	120°	3000	25 000	> 80	∅ 205 x 32	Blanco	10
86491	15	2 x 15	1 125	120°	3000	25 000	> 80	200 x 200 x32	Blanco	10
86492	15	2 x 15	1 125	120°	6500	25 000	> 80	∅ 205 x 32	Blanco	10
86493	15	2 x 15	1 125	120°	6500	25 000	> 80	200 x 200x32	Blanco	10
86494	24	2 x 23	1 800	120°	3000	25 000	> 80	∅ 238 x 32	Blanco	10
86495	24	2 x 23	1 800	120°	3000	25 000	> 80	225 x 225 x 32	Blanco	10
86496	24	2 x 23	1 800	120°	6500	25 000	> 80	∅ 238 x 32	Blanco	10
86497	24	2 x 23	1 800	120°	6500	25 000	> 80	225 x 225 x 32	Blanco	10

* En sustitución de lámparas CFLI compactas / In the replacement of compact CFLI lamps.



LEDVANCE® FOCOLUM

Luminaria para empotrar tipo spot. Disponible en versión redondo y cuadrado, en temperatura Luz Cálida (3000 K). De fácil y rápida instalación.

Luminaire to embed, spot type. Available in round and square versions, in Warm Light temperature: (3000 K). Quick and easy to install.

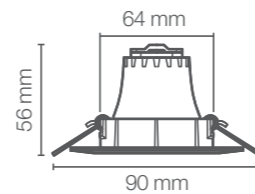

APLICACIONES / APPLICATIONS



Código Sku	Potencia Power (W)	Equivalencia Equivalence Halógeno (W)	Flujo Luminoso Luminous Flux (lm)	Ángulo de Apertura Opening Angle	Temp. de Color Color Temp. (K)	Vida Útil Life (h)	IRC CRI	Dimensiones Dimensions (mm)	Color de Producto Product Color	Unidades por Caja Units per box
86435	3.3	35	270	36°	3 000	25 000	> 80	∅ 90 x 56	Blanco	6
86436	4.5	50	450	42°	3 000	25 000	> 80	90 x 90 x 56	Blanco	6
86437	4.5	50	450	42°	3 000	25 000	> 80	∅ 90 x 56	Blanco	6

* En sustitución de lámparas halógenas convencionales / In replacement of conventional halogen lamps.



LEDVANCE® INSERT SQUARE

Luminaria de techo para empotrar con diseño ultra delgado y con una distribución de luz homogénea. Equipada con LED de alta potencia. Disponible en versión cuadrado con tres temperaturas de color: Luz Cálida (3000 K), Blanco Frío (4000 K) y Luz de Día (6500 K). Instalación fácil y rápida.

Indoor lighting with ultra slim design and homogeneous distribution light. Equipped with high power led. Available in three versions: Warm Light (3000 K), Cool Light (4000 K) and Day Light (6500 K). Easy and fast installing.

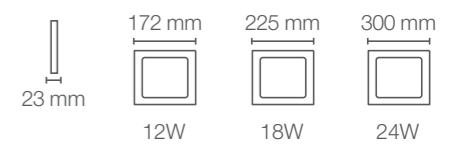

APLICACIONES / APPLICATIONS



Código Sku	Potencia Power (W)	Equivalencia Equivalence CFLI (W)	Flujo Luminoso Luminous Flux (lm)	Ángulo de Apertura Opening Angle	Temp. de Color Color Temp. (K)	Vida Útil Life (h)	IRC CRI	Dimensiones Dimensions (mm)	Color de Producto Product Color	Unidades por Caja Units per box
86442	12	2 x 13	950	120°	3000	25 000	>80	172 x 172 x 23	Blanco	10
86443	12	2 x 13	950	120°	4000	25 000	>80	172 x 172 x 23	Blanco	10
86444	12	2 x 13	950	120°	6500	25 000	>80	172 x 172 x 23	Blanco	10
86448	18	2 x 15	1 500	120°	3000	25 000	>80	225 x 225 x 23	Blanco	10
86449	18	2 x 15	1 500	120°	4000	25 000	>80	225 x 225 x 23	Blanco	10
86450	18	2 x 15	1 500	120°	6500	25 000	>80	225 x 225 x 23	Blanco	10
86456	24	2 x 23	2 200	120°	6500	25 000	>80	300 x 300 x 23	Blanco	10

* En sustitución de lámparas CFLI compactas / In the replacement of compact CFLI lamps.



LEDVANCE® INSERT ROUND

Luminaria de techo para empotrar con diseño ultra delgado y con una distribución de luz homogénea. Equipada con LED de alta potencia. Disponible en versión redondo con tres temperaturas de color: Luz Cálida (3000 K), Blanco Frío (4000 K) y Luz de Día (6500 K). Instalación fácil y rápida.

Indoor lighting with ultra slim design and homogeneous distribution light. Equipped with high power led. Available in three versions: Warm Light (3000 K), Cool Light (4000 K) and Day Light (6500 K). Easy and fast installing.

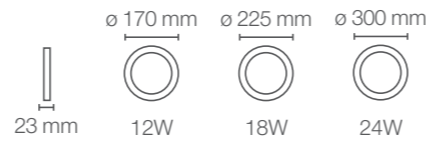

APLICACIONES / APPLICATIONS



Código Sku	Potencia Power (W)	Equivalencia Equivalence CFLI (W)	Flujo Luminoso Luminous Flux (lm)	Ángulo de Apertura Opening Angle	Temp. de Color Color Temp. (K)	Vida Útil Life (h)	IRC CRI	Dimensiones Dimensions (mm)	Color de Producto Product Color	Unidades por Caja Units per box
86445	12	2 x 13	950	120°	3000	25 000	>80	Ø 170 x 23	Blanco	10
86446	12	2 x 13	950	120°	4000	25 000	>80	Ø 170 x 23	Blanco	10
86447	12	2 x 13	950	120°	6500	25 000	>80	Ø 170 x 23	Blanco	10
86451	18	2 x 15	1 500	120°	3000	25 000	>80	Ø 225 x 23	Blanco	10
86452	18	2 x 15	1 500	120°	4000	25 000	>80	Ø 225 x 23	Blanco	10
86453	18	2 x 15	1 500	120°	6500	25 000	>80	Ø 225 x 23	Blanco	10
86458	24	2 x 23	2 200	120°	4000	25 000	>80	Ø 300 x 23	Blanco	10
86459	24	2 x 23	2 200	120°	6500	25 000	>80	Ø 300 x 23	Blanco	10

* En sustitución de lámparas CFLI compactas / In the replacement of compact CFLI lamps.



LEDVANCE® LIVIN

Luminaria de techo para sobreponer con diseño lineal y moderno. Está equipada con LED de alta potencia con luz blanca, que ilumina el ambiente de manera uniforme. Instalación fácil y rápida. Disponible en versiones corta y larga.

Indoor lighting with a linear and modern design. Equipped with high power led with day light, it lights up uniformly the environment. Easy and fast installing.

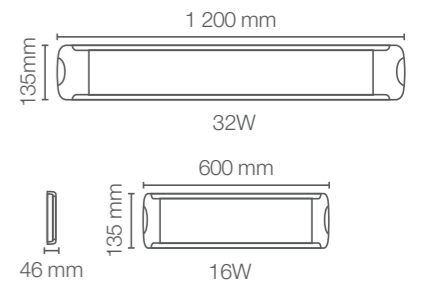

APLICACIONES / APPLICATIONS

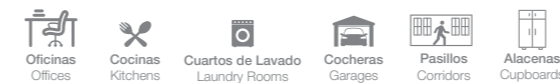

Código Sku	Potencia Power (W)	Equivalencia Equivalence Fluor. (W)	Flujo Luminoso Luminous Flux (lm)	Ángulo de Apertura Opening Angle	Temp. de Color Color Temp. (K)	IRC CRI	Vida Útil Life (h)	Dimensiones Dimensions (mm)	Color de Producto Product Color	Unidades por Caja Units per box
83194	16	2 x 17 T8	1 400	110°	5000	>80	30 000	600 x 135 x 46	Blanco	10
83195	32	2 x 32 T8	3 000	110°	5000	>80	30 000	1200 x 135 x 46	Blanco	8

* En sustitución de lámparas fluorescentes tubulares / In the replacement of tubular fluorescent lamps.



LEDVANCE® SMART+ LIGHTING

Con la tecnología SMART+ de LEDVANCE, podrás transformar tu hogar en un mundo de experiencias creativas y dinámicas, creando escenas, grupos y programaciones acogedoras y versátiles.

With LEDVANCE's SMART+ technology, you can transform your home into a world of creative and dynamic experiences, creating welcoming and versatile scenes, groups and schedules.



DOWNLIGHT
88744



CEILING
88745



TIRA LED
88746

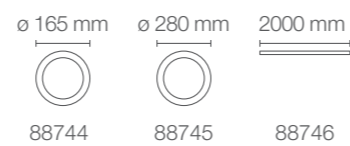

APLICACIONES / APPLICATIONS



Código Sku	Potencia Power (W)	Equivalencia Equivalence CFLI (W)	Flujo Luminoso Luminous Flux (lm)	Ángulo de Apertura Opening Angle	Temp. de Color Color Temp. (K)	Vida Útil Life (h)	IRC CRI	Dimensiones Dimensions (mm)	Color de Producto Product Color	Unidades por Caja Units per box
88744	15	2 x 15	1 200	110°	RGBW	15 000	>80	Ø 165 x 48	Blanco	12
88745	22	2 x 23	1 800	110°	RGBW	15 000	>80	Ø 280 x 55	Blanco	10
88746	4.25 W/m	NA	380 lm/m	120°	RGBW	15 000	>80	2000 x 20 x 2.8	Blanco	12

* En sustitución de lámparas CFLI compactas / In the replacement of compact CFLI lamps.



PROFESIONAL / COMERCIAL



LEDVANCE® PANEL BACKLIT

LEDVANCE PANEL cuenta con un nuevo diseño implementando tecnología Backlit lo que permite una mejor distribución de luz sin percibir los puntos de luz en el difusor, está fabricado en cuerpo de aluminio y cuenta con alta eficacia de hasta 110 lm/W, disponible en 3 versiones: 60x60 cm, 30x120 cm (36W) y 60x120 cm (54W).

LEDVANCE PANEL has a new design implementing Backlit technology which allows a better light distribution without perceiving the light spots in the diffuser, it is made of aluminum body and has high efficiency of up to 110 lm/W, available in 3 versions : 60x60 cm, 30x120 cm (36W) and 60x120 cm (54W).



- HASTA 30% DE AHORRO DE ENERGÍA
- 5 AÑOS DE GARANTÍA
- 100-277-V
- IP40
- SIN CORTES DIAGONALES
- DRIVER EXTERNO
- DISTRIBUCIÓN DE LUZ UNIFORME

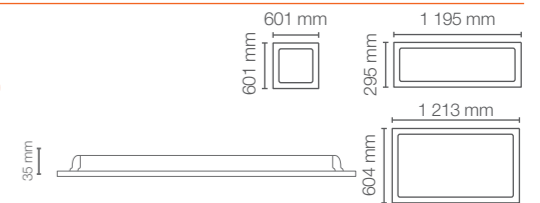

APLICACIONES / APPLICATIONS



Código Sku	Potencia Power (W)	Equivalencia Equivalence Fluor. (W)	Flujo Luminoso Luminous Flux (lm)	Ángulo de Apertura Opening Angle	Temp. de Color Color Temp. (K)	Vida Útil Life (h)	IRC CRI	Dimensiones Dimensions (mm)	Color de Producto Product Color	Unidades por Caja Units per box
86840	36	3 x 14W T5 o 2 x 32W T8	4 000	110°	3000	50 000	>80	601 x 601 x 36	Blanco	5
86841	36	3 x 14W T5 o 2 x 32W T8	4 320	110°	4000	50 000	>80	601 x 601 x 36	Blanco	5
86842	36	3 x 14W T5 o 2 x 32W T8	4 320	110°	6500	50 000	>80	601 x 601 x 36	Blanco	5
80529	36	2 x 28W T5 o 2 x 32W T8	4 000	120°	3000	50 000	>80	295 x 1195 x35	Blanco	5
80530	36	2 x 28W T5 o 2 x 32W T8	4 000	120°	4000	50 000	>80	295 x 1195 x35	Blanco	5
80531	36	2 x 28W T5 o 2 x 32W T8	4 000	120°	6500	50 000	>80	295 x 1195 x35	Blanco	5
80533	54	3 x 28W T5 o 3 x 32W T8	6 000	120°	4000	50 000	>80	604 x 1213 x35	Blanco	5
86847	54	3 x 28W T5 o 3 x 32W T8	6 480	110°	6500	50 000	>80	601 x 1213 x 35	Blanco	5



Accesorios*
Accessories*

80549	Marco para sobreponer Panel 621 x 621 x 72.4
80551	Marco para sobreponer Panel 1213 x 313 x 72.4
80552	Marco para sobreponer Panel 621 x 1221 x 72.4
80553	Kit de Suspensión
86852	Clips de Montaje

* Se venden por separado

* En sustitución de lámparas fluorescentes tubulares / In replacement of tubular fluorescent lamps.



LEDVANCE® SPOTLIGHT

Luminaria de techo para empotrar tipo spot, utilizada para destacar objetos o ambientes. Lámpara ajustable con recubrimiento antirreflejante, ideal para iluminación decorativa en establecimientos, oficinas, centros comerciales y hoteles. Acabado en blanco mate.

Ceiling luminaire to embed, spot type. It is used to highlight objects or environments. Adjustable lamp with anti-glare coating. It is ideal for decorative lighting in shops, offices, shopping centers. In matt white.



-
-
-
-
-
-
-
-

APLICACIONES / APPLICATIONS



Código Sku	Potencia Power (W)	Equivalencia Equivalence Halógena (W)	Flujo Luminoso Luminous Flux (lm)	Ángulo de Apertura Opening Angle	Temp. de Color Color Temp. (K)	IRC CRI	Vida Útil Life (h)	Dimensiones Dimensions (mm)	Color de Producto Product Color	Unidades por Caja Units per box
82876	10	75	800	36°	3000	>80	30 000	Ø 90 x 47	Blanco	20
85271	10	75	800	36°	6500	>80	30 000	Ø 90 x 47	Blanco	20

* En sustitución de lámparas halógenas convencionales / In replacement of conventional halogen lamps.

LEDVANCE® SPOTLIGHT MODULAR

Luminaria de techo para empotrar tipo spot, con LED COB de alta calidad que realza perfectamente el color de los objetos alcanzando hasta 1,800 lúmenes. Combinándolo con alguno de sus 9 accesorios en acabado blanco mate puedes crear hasta 36 combinaciones diferentes para lucir espacios creativos y espectaculares.

Spot-type embed ceiling luminaire with high quality COB LED that perfectly enhances the color of objects, reaching up to 1,800 lumens. Combining it with one of its 9 accessories in matte white finish, you can create up to 36 combinations to design creative and spectacular spaces.



-
-
-
-
-

APLICACIONES / APPLICATIONS



Código Sku	Potencia Power (W)	Equivalencia Equivalence Halógena (W)	Flujo Luminoso Luminous Flux (lm)	Ángulo de Apertura Opening Angle	Temp. de Color Color Temp. (K)	IRC CRI	Vida Útil Life (h)	Dimensiones Dimensions (mm)	Color de Producto Product Color	Unidades por Caja Units per box
80697	13	1 X 90	1 105	36°	3000	>80	50 000	Ø50 x 61	Negro	20
80698	13	1 X 90	1 210	36°	4000	>80	50 000	Ø50 x 61	Negro	20
80699	18	1 X 150	1 700	36°	3000	>80	50 000	Ø50 x 81	Negro	20
80700	18	1 X 150	1 800	36°	4000	>80	50 000	Ø50 x 81	Negro	20

*En sustitución de lámparas halógenas convencionales / In replacement of conventional halogen lamps.

Código Sku	Versión	Tamaño de corte	Material	Peso Weight (g)	Dimensiones Dimensions (mm)	Color de Producto Product Color	Unidades por Caja Units per box
80701	DEEP TRIM	Ø80	Aluminio	75	Ø85 x 46.8	Blanco	20
80702	OVAL HOLE TRIM	Ø80	Aluminio	110	Ø85 x 34.5	Blanco	20
80703	CIRCULAR HOLE TRIM	Ø80	Aluminio	110	Ø85 x 34.5	Blanco	20
80704	TILT TRIM	Ø80	Aluminio	70	Ø90 x 24.8	Blanco	20
80705	DEEP TRIM	Ø95	Aluminio	90	Ø100 x 45.8	Blanco	20
80706	ASYMMETRICAL TRIM	Ø95	Aluminio	95	Ø100 x 64	Blanco	20
80707	TILT TRIM	Ø95	Aluminio	105	Ø110 x 32	Blanco	20
80708	SQUARE DEEP TRIM	Ø95	Aluminio	115	Ø100 x 50	Blanco	20
80709	SQUARE TILT TRIM	Ø95	Aluminio	160	Ø110 x 35	Blanco	20



DEEP TRIM Ø80



DEEP TRIM Ø95



OVAL HOLE TRIM Ø80



CIRCULAR HOLE TRIM Ø80



TILT TRIM Ø80



TILT TRIM Ø95



ASYMMETRICAL TRIM Ø95



SQUARE DEEP TRIM Ø95



SQUARE TILT TRIM Ø95

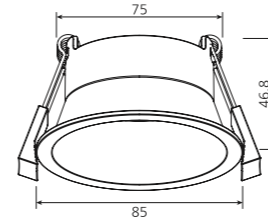

DEEP TRIM Ø80

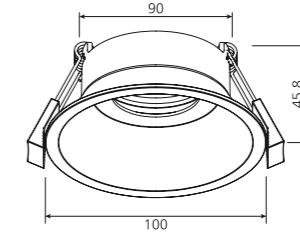

DEEP TRIM Ø95

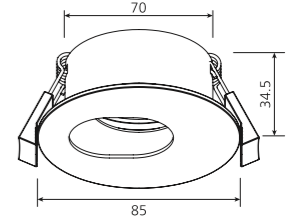

OVAL HOLE TRIM Ø80

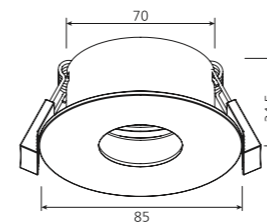

CIRCULAR HOLE TRIM Ø80

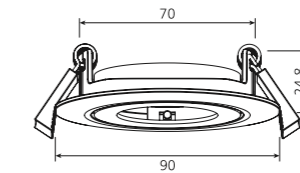

TILT TRIM Ø80

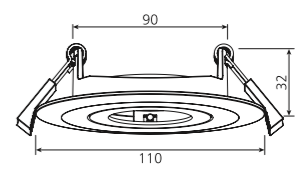

TILT TRIM Ø95

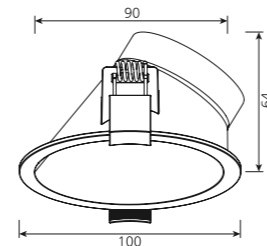

ASYMMETRICAL TRIM Ø95

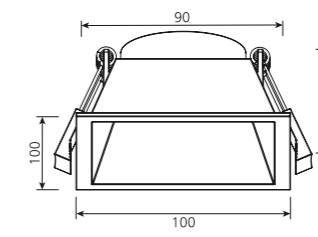

SQUARE DEEP TRIM Ø95

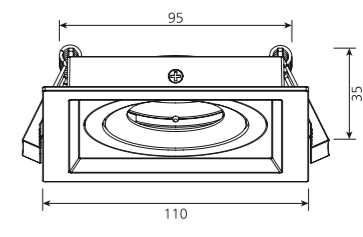

SQUARE TILT TRIM Ø95



LEDVANCE® DOWNLIGHT

Luminaria de techo para empotrar, ideal para ambientes profesionales. Acabado en aluminio blanco mate.

Ceiling luminaire to embed. It is ideal for professional environments. Finished in matt white aluminum.

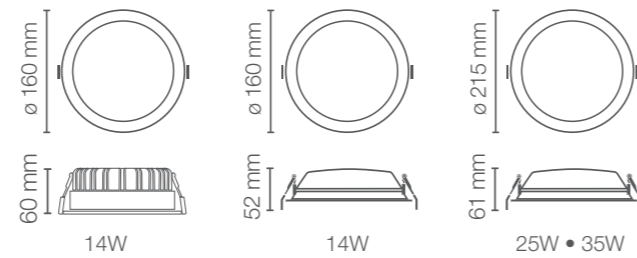

APLICACIONES / APPLICATIONS

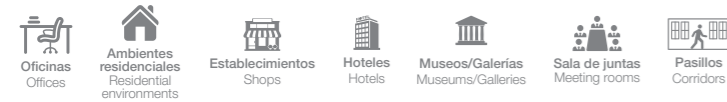

Código Sku	Potencia Power (W)	Equivalencia Equivalence CFL (W)	Flujo Luminoso Luminous Flux (lm)	Ángulo de Apertura Opening Angle	Temp. de Color Color Temp. (K)	IRC CRI	Vida Útil Life (h)	Dimensiones Dimensions (mm)	Color de Producto Product Color	Unidades por Caja Units per box
82878	14	2 x 18	1 200	95°	3 000	>80	30 000	Ø 160 x 60	Blanco	18
86708	14	2 x 18	1 200	95°	6 500	>80	30 000	Ø 160 x 52	Blanco	8
86709	25	2 x 32	2 200	100°	3 000	>80	30 000	Ø 215 x 61	Blanco	8
86710	25	2 x 32	2 200	100°	6 500	>80	30 000	Ø 215 x 61	Blanco	8
86711	35	2 x 42	3 300	100°	4 000	>80	30 000	Ø 215 x 61	Blanco	8

* En sustitución de lámparas fluorescentes compactas no integradas / In the replacement of non-integrated compact fluorescent lamps.

LEDVANCE® DOWNLIGHT PARA BOTE INTEGRAL

Luminaria con controlador integrado para su aplicación en bote integral de 8 cm y 12 cm. Con construcción en aluminio y difusor en policarbonato lo que permite una distribución uniforme de luz. Disponible en 3 temperaturas 3 000 K / 4 000 K / 6 500 K y además una versión atenuable.

Luminaire with integrated controller for application in 8 cm and 12 cm integral boat. With construction in aluminum and diffuser in polycarbonate that allows a uniform distribution of light. Available in 3 temperatures 3 000 K / 4 000 K / 6 500 K and also an dimmable version.

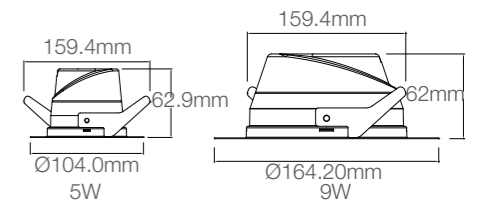

APLICACIONES / APPLICATIONS



Código Sku	Potencia Power (W)	Equivalencia Equivalence CFL (W)	Flujo Luminoso Luminous Flux (lm)	Ángulo de Apertura Opening Angle	Temp. de Color Color Temp. (K)	Vida Útil Life (h)	IRC CRI	Dimensiones Dimensions (mm)	Color de Producto Product Color	Unidades por Caja Units per box
80304	5	1 x 13	400	110°	6500	30 000	>80	Ø104x629	Blanco	12
80305	9	2 x 13	720	110°	3000	30 000	>80	Ø164.2x620	Blanco	12
80306	9	2 x 13	720	110°	4000	30 000	>80	Ø164.2x620	Blanco	12
80307	9	2 x 13	720	110°	6500	30 000	>80	Ø164.2x620	Blanco	12
80310	5	1 x 13	400	110°	6500	30 000	>80	Ø104x629	Blanco	12
80313	9	2 x 13	720	110°	6500	30 000	>80	Ø164.2x620	Blanco	12

* En sustitución de lámparas CFLI compactas / In the replacement of compact CFLI lamps.



LEDVANCE® DOWNLIGHT COMFORT

Luminaria de techo para empotrar con 3 temperaturas de color en el mismo producto: 3000 K, 4000 K y 5700 K. Disponible en dos potencias con recubrimiento antideslumbrante (UGR <22).

Ceiling luminaire to embed with 3 color temperatures in the same product: 3000 K, 4000 K and 5700 K. Available in two versions with anti-glare coating (UGR <22).

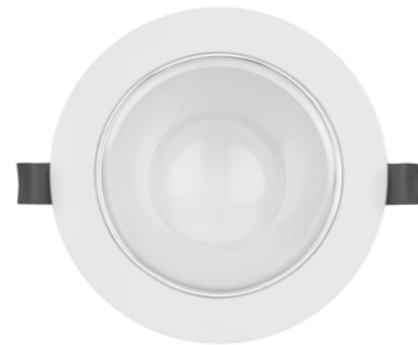

-
-
-
-
-
-
-
-

107 mm
145 mm
82 mm
13W

173 mm
228 mm
98 mm
20W

APLICACIONES / APPLICATIONS

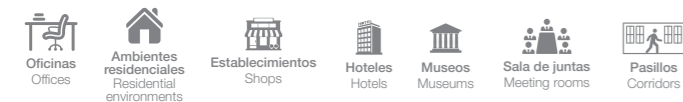

Código Sku	Potencia Power (W)	Equivalencia Equivalence CFLI (W)	Flujo Luminoso Luminous Flux (lm)	Ángulo de Apertura Opening Angle	Temp. de Color Color Temp. (K)	IRC CRI	Vida Útil Life (h)	Dimensiones Dimensions (mm)	Color de Producto Product Color	Unidades por Caja Units per box
86814	13	2 x 18	(3000 K) 1 030 (4000 K) 1 210 (5700 K) 1 110	60°	3000 4000 5700	>80	50 000	Ø 145 x 82	Blanco	8
86816	20	2 x 23	(3000 K) 1 720 (4000 K) 1 930 (5700 K) 1 810	60°	3000 4000 5700	>80	50 000	Ø 228 x 98	Blanco	8

* En sustitución de lámparas CFLI compactas / In the replacement of compact CFLI lamps.

LEDVANCE® LINEAR

Luminaria de techo para sobreponer con diseño lineal y moderno. Equipada con LED de alta potencia, que ilumina el ambiente de manera uniforme. Disponible en temperaturas de color: Luz Cálida (3000 K), Blanco Frío (4000 K) y Luz de Día (6500 K).

Indoor lighting with a linear and modern design. Equipped with high power led with day light and cool light, it lights up uniformly the environment. Easy and fast installing. Available in versions: Warm Light (3000 K), Cool Light (4000 K) and Day Light (6500 K).



-
-
-
-
-
-

573 mm
36 mm
8W

1 173 mm
36 mm
14W • 20W

APLICACIONES / APPLICATIONS



Código Sku	Potencia Power (W)	Equivalencia Equivalence Fluor. (W)	Flujo Luminoso Luminous Flux (lm)	Ángulo de Apertura Opening Angle	Temp. de Color Color Temp. (K)	IRC CRI	Vida Útil Life (h)	Dimensiones Dimensions (mm)	Color de Producto Product Color	Unidades por Caja Units per box
86510	8	1 x 17 T8	800	100°	3000	>80	30 000	573 x 28 x 36	Blanco	15
86398	8	1 x 17 T8	800	100°	4000	>80	30 000	573 x 28 x 36	Blanco	15
86399	8	1 x 17 T8	800	100°	6500	>80	30 000	573 x 28 x 36	Blanco	15
86512	14	1 x 25 T8	1 400	100°	3000	>80	30 000	1173 x 28 x 36	Blanco	15
86400	14	1 x 25 T8	1 400	100°	4000	>80	30 000	1173 x 28 x 36	Blanco	15
86401	14	1 x 25 T8	1 400	100°	6500	>80	30 000	1173 x 28 x 36	Blanco	15
86514	20	1 x 32 T8	2 000	100°	3000	>80	30 000	1173 x 28 x 36	Blanco	15
86402	20	1 x 32 T8	2 000	100°	4000	>80	30 000	1173 x 28 x 36	Blanco	15
86403	20	1 x 32 T8	2 000	100°	6500	>80	30 000	1173 x 28 x 36	Blanco	15

* En sustitución de lámparas fluorescentes tubulares / In replacement of tubular fluorescent lamps.



LEDVANCE® LINEAR PENDANT

Luminaria de techo para suspender, ahora con mayor eficacia que le garantiza la mejor iluminación para espacios comerciales y corporativos, luzca un ambiente elegante y sofisticado gracias a su iluminación directa e indirecta la cual a su vez ayuda a mitigar el efecto caverna.

Ceiling luminaire to suspend, now with greater efficiency that guarantees the best lighting for commercial and corporate spaces, looks elegant and sophisticated thanks to its direct and indirect lighting which in turn helps to mitigate the cavern effect.

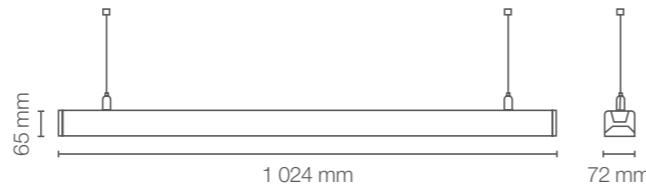
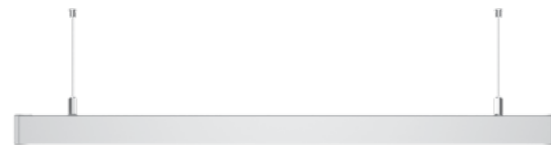

APLICACIONES / APPLICATIONS



Código Sku	Potencia Power (W)	Equivalencia Fluor. (W)	Flujo Luminoso Luminous Flux (lm)	Ángulo de Apertura Opening Angle	Temp. de Color Color Temp. (K)	IRC CRI	Vida Útil Life (h)	Dimensiones Dimensions (mm)	Color de Producto Product Color	Unidades por Caja Units per box
80179	36	2 x 28W T5 o 2 x 32W T8	3 300	110°	○ 4000	>80	50 000	1024 x 72 x 65	Blanco	6

* En sustitución de lámparas fluorescentes tubulares / In replacement of tubular fluorescent lamps.



LEDVANCE® LOWBAY

Luminaria con diseño ligero y compacto que se puede integrar en cualquier espacio proporcionando una apariencia más discreta y estética. Su alta eficacia de 135 lm/W permite reducir el consumo de energía hasta un 60% en comparación con tecnología tradicional. Cuenta con protocolo de atenuación que permitirá integrarla a un sistema de control alámbrico o inalámbrico de acuerdo a la preferencia del cliente.

Light and compact design luminaire, can be integrated into any space providing a more discreet and aesthetic appearance. Its high efficiency of 135 lm/W allows energy consumption to be reduced by up to 60% compared to traditional technology. It has an attenuation protocol that will allow it to be integrated into a wired or wireless control system according to the customer's preference.

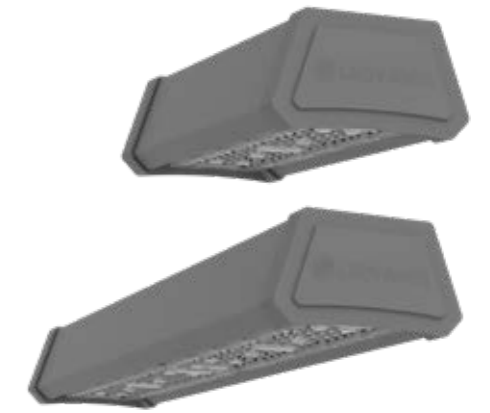

APLICACIONES / APPLICATIONS



Código Sku	Potencia Power (W)	Equivalencia Fluor. T5 (W)	Flujo Luminoso Luminous Flux (lm)	Ángulo de Apertura Opening Angle	Temp. de Color Color Temp. (K)	IRC CRI	Vida Útil Life (h)	Dimensiones Dimensions (mm)	Color de Producto Product Color	Unidades por Caja Units per box
80153	50	2 x 54	6 750	90°	● 5000	>80	50 000	269 x 128 x 60	Gris	10
80154	100	4 x 54	13 500	90°	● 5000	>80	50 000	526 x 128 x 60	Gris	6

* En sustitución de lámparas fluorescentes tubulares / In replacement of tubular fluorescent lamps.



LEDVANCE® PENDULUM

Accesorio para lámparas LED e Incandescentes con base E27 ideal para crear una atmósfera clásica y retro. Combinable con diferentes ambientes y propuestas decorativas.

Accessory for LED and incandescent lamps with E27 base ideal to create a classic and retro atmosphere. Combination with different environments and decorative proposals.



*Lámpara no incluida

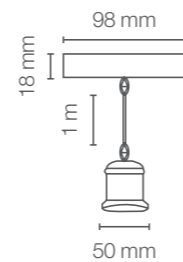

APLICACIONES / APPLICATIONS



Compatible con nuestra línea de lámparas LED VINTAGE 1906.

Código Sku	Material	Potencia Max. Max. Power (W)	Base	Dimensiones Dimensions (mm)	Color de Producto Product Color	Unidades por Caja Units per box
86730	Acero	LED 31W o INCANDESCENTE 40W	E27	Ø 98 x 1000	Negro	12
86731	Acero	LED 31W o INCANDESCENTE 40W	E27	Ø 98 x 1000	Bronce	12

LEDVANCE® TRACKLIGHT

Es una tendencia en la iluminación a detalle, adecuada para aplicaciones comerciales, con una iluminación moderna y decorativa. Ideal para enfocar objetos y destacar espacios.

A trend towards lighting in detail, it is suitable for commercial applications, with modern and decorative lighting, ideal for focusing objects and highlighting spaces.



*Lámpara no incluida

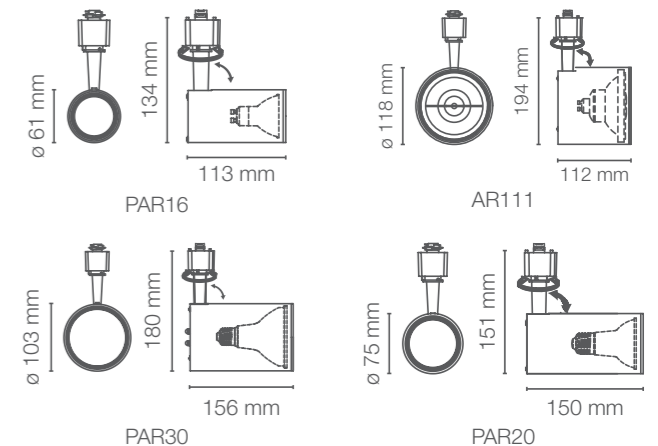

APLICACIONES / APPLICATIONS

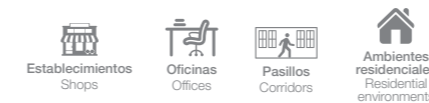

Compatible con nuestra línea de lámparas LED SUPERSTAR.

Código Sku	Versión	Material	Potencia Max. Max. Power (W)	Base	Dimensiones Dimensions (mm)	Peso Weight (g)	Color de Producto Product Color	Unidades por caja Units per box
86636	AR111	Aluminio	14	GU10	112 x 118 x 194	440	Negro	12
86637	AR111	Aluminio	14	GU10	112 x 118 x 194	440	Blanco	12
86632	PAR16	Aluminio	11	GU10	113 x 61 x 134	235	Negro	12
86633	PAR16	Aluminio	11	GU10	113 x 61 x 134	235	Blanco	12
86638	PAR20	Aluminio	7	E27	150 x 75 x 151	340	Negro	12
86639	PAR20	Aluminio	7	E27	150 x 75 x 151	340	Blanco	12
86640	PAR30 LN	Aluminio	31	E27	156 x 103 x 180	425	Negro	12
86641	PAR30 LN	Aluminio	31	E27	156 x 103 x 180	425	Blanco	12
86644	PAR38	Aluminio	16	E27	270 x 128 x 145	288	Negro	12
86645	PAR38	Aluminio	16	E27	270 x 128 x 145	288	Blanco	12

RIELES Y CONECTORES / RAILS AND CONNECTORS



RIELES / RAILS

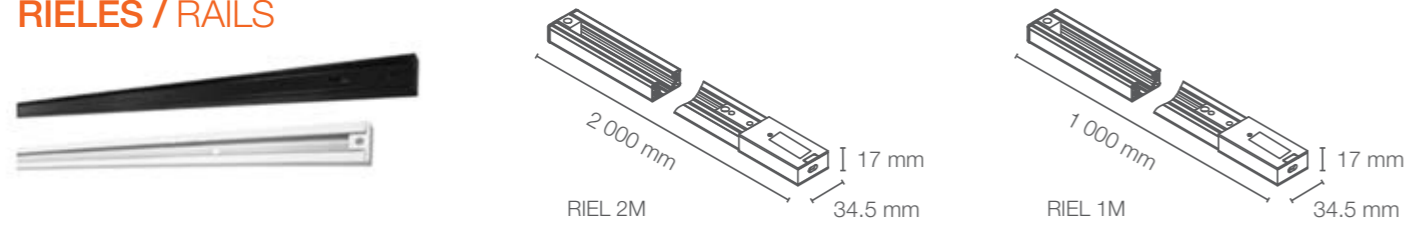

Código Sku	Versión	Material	Potencia Max. Max. Power (W)	Dimensiones Dimensions (mm)	Peso Weight (g)	Color del Producto Product Color	Spots Max. Por Riel Max. Spots Per Rail	Unidades por caja Units per box
86646	Riel 1M	Aluminio	190	1000 x 34.5 x 17	500	Negro	AR111 - 6 PAR16 - 6 PAR20 - 6 PAR30 LN - 4 PAR38 - 4	12
86647	Riel 1M	Aluminio	190	1000 x 34.5 x 17	500	Blanco	AR111 - 6 PAR16 - 6 PAR20 - 6 PAR30 LN - 4 PAR38 - 4	12
86648	Riel 2M	Aluminio	190	2000 x 34.5 x 17	1000	Negro	AR111 - 11 PAR16 - 11 PAR20 - 11 PAR30 LN - 7 PAR38 - 7	12
86649	Riel 2M	Aluminio	190	2000 x 34.5 x 17	1000	Blanco	AR111 - 11 PAR16 - 11 PAR20 - 11 PAR30 LN - 7 PAR38 - 7	12

CONECTORES / CONNECTORS

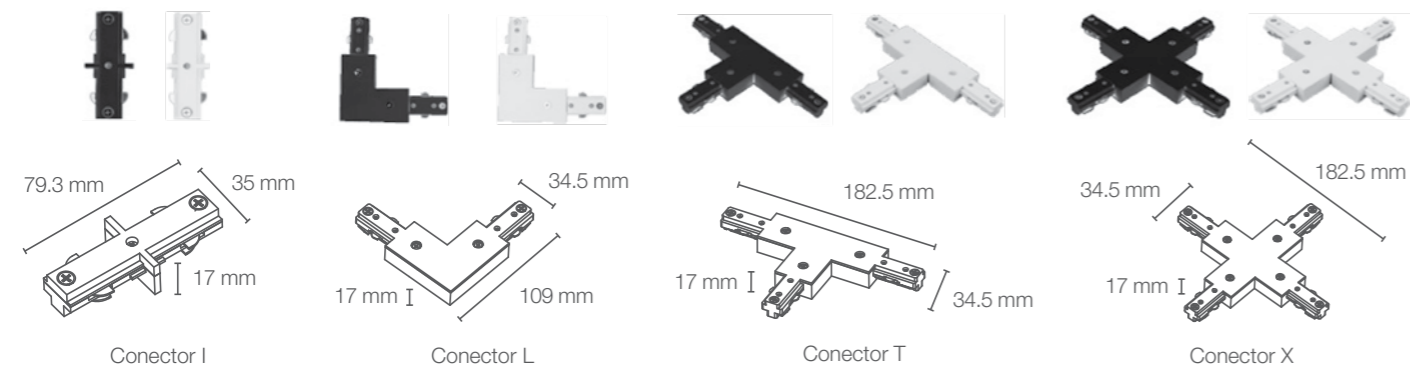

Código Sku	Versión	Material	Potencia Max. Max. Power (W)	Dimensiones Dimensions (mm)	Peso Weight (g)	Color del Producto Product Color	Unidades por caja Units per box
86650	Conector I	Aluminio	190	79.3 x 35 x 17	28	Negro	12
86651	Conector I	Aluminio	190	79.3 x 35 x 17	28	Blanco	12
86652	Conector L derecho	Aluminio	190	109 x 34.5 x 17	104	Negro	12
86653	Conector L derecho	Aluminio	190	109 x 34.5 x 17	104	Blanco	12
86758	Conector L izquierdo	Aluminio	190	109 x 34.5 x 17	104	Negro	12
86759	Conector L izquierdo	Aluminio	190	109 x 34.5 x 17	104	Blanco	12
86722	Conector T derecho	Aluminio	190	182.5 x 34.5 x 17	148	Negro	12
86723	Conector T derecho	Aluminio	190	182.5 x 34.5 x 17	148	Blanco	12
86760	Conector T izquierdo	Aluminio	190	182.5 x 34.5 x 17	148	Negro	12
86761	Conector T izquierdo	Aluminio	190	182.5 x 34.5 x 17	148	Blanco	12
86724	Conector X	Aluminio	190	182.5 x 34.5 x 17	196	Negro	12
86725	Conector X	Aluminio	190	182.5 x 34.5 x 17	196	Blanco	12

RECESSED RAIL & FLEXIBLE CONNECTOR



RIEL PARA EMPOTRAR / RECESSED RAIL

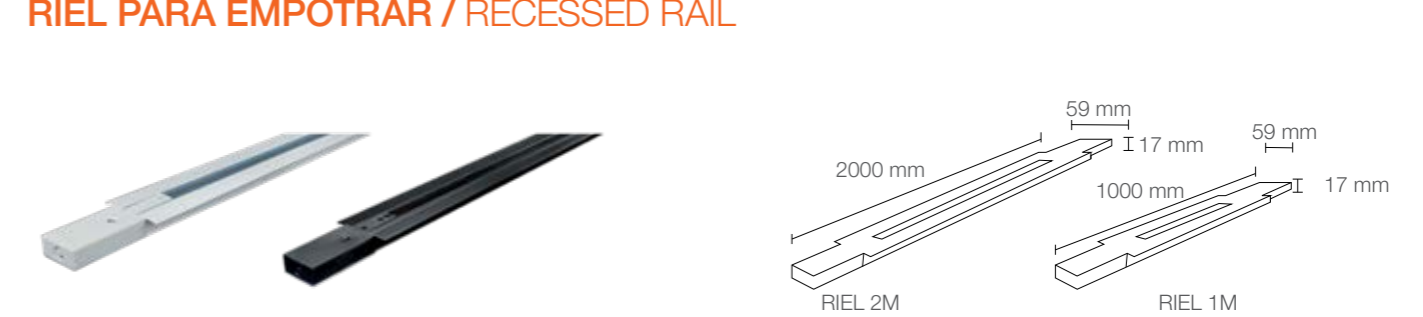

Código Sku	Versión	Material	Potencia Max. Max. Power (W)	Dimensiones Dimensions (mm)	Peso Weight (g)	Color del Producto Product Color	Spots Max. Por Riel Max. Spots Per Rail	Unidades por caja Units per box
80214	Riel 1M	Aluminio	190	1000x59x17	575	Negro	AR111 - 6 PAR16 - 6 PAR20 - 6 PAR30 LN - 4 PAR38 - 4	12
80215	Riel 1M	Aluminio	190	1000x59x17	575	Blanco	AR111 - 6 PAR16 - 6 PAR20 - 6 PAR30 LN - 4 PAR38 - 4	12
80216	Riel 2M	Aluminio	190	2000x59x17	1120	Negro	AR111 - 11 PAR16 - 11 PAR20 - 11 PAR30 LN - 7 PAR38 - 7	12
80217	Riel 2M	Aluminio	190	2000x59x17	1120	Blanco	AR111 - 11 PAR16 - 11 PAR20 - 11 PAR30 LN - 7 PAR38 - 7	12

CONECTOR FLEXIBLE / FLEXIBLE CONNECTOR



Código Sku	Versión	Material	Potencia Max. Max. Power (W)	Dimensiones Dimensions (mm)	Peso Weight (g)	Color del Producto Product Color	Unidades por caja Units per box
80218	Conector Flexible	Aluminio	190	300x35x17	155	Negro	12
80219	Conector Flexible	Aluminio	190	300x35x17	155	Blanco	12



LEDVANCE® TRACKLIGHT ZOOM

Su diseño SCALE exclusivo de LEDVANCE y su módulo de LED de 25W de alta reproducción cromática, lo convierten en la solución en iluminación de acento más versátil y completa para aplicaciones comerciales, destacando espacios y enfocando objetos adecuándose a sus necesidades con sus 4 tipos de ajuste: Rotación, Inclinación, Atenuación y Acentuación:

Its exclusive SCALE design from LEDVANCE and its high color rendering 25W LED module, make it the most versatile and complete accent lighting solution for commercial applications, highlighting spaces and focusing objects according to your needs with its 4 types of adjustment: Rotation angle, Tilt angle, Dimmable and Beam angle:

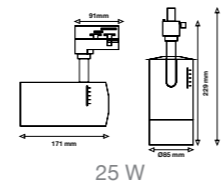
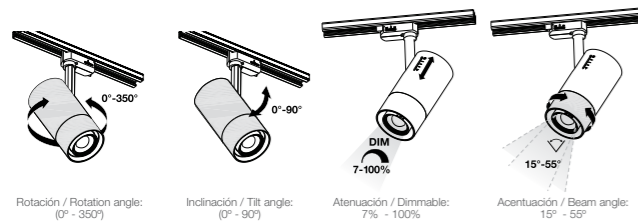

APLICACIONES / APPLICATIONS



Código Sku	Potencia Power (W)	Equivalencia Equivalence Halógena (W)	Flujo Luminoso Luminous Flux (lm)	Ángulo de Apertura Opening Angle	Temp. de Colo Color Temp. (K)	IRC CRI	Vida Útil Life (h)	Dimensiones Dimensions (mm)	Color de Producto Product Color	Unidades por Caja Units per box
80625	25	1 X 90	1 500	15° - 55°	3 000	97	50 000	93 X 85 X 265	Blanco	4
80626	25	1 X 90	1 500	15° - 55°	4 000	97	50 000	93 X 85 X 265	Blanco	4
80627	25	1 X 90	1 500	15° - 55°	3 000	97	50 000	93 X 85 X 265	Negro	4
80628	25	1 X 90	1 500	15° - 55°	4 000	97	50 000	93 X 85 X 265	Negro	4

*En sustitución de lámparas halógenas convencionales / In replacement of conventional halogen lamps.



LEDVANCE® MULTISPOT

Ideal para lámparas de alto flujo luminoso, con acabado en aluminio y un diseño elegante, es perfecta para aplicaciones comerciales incluso residenciales. Disponible en 1, 2 y 3 spots con conector eléctrico incluido.

Aluminum housing for PAR30 and AR111 lamps for embedding, with compact design and easy installation. Available for one, two or even three lamps.



*Lámpara no incluida



Compatible con nuestra línea de lámparas LED SUPERSTAR.

APLICACIONES / APPLICATIONS



Código Sku	Versión	Material	Potencia Max. Max. Power (W)	Base	Dimensiones Dimensions (mm)	Peso Weight (g)	Color de Producto Product Color	Unidades por caja Units per box
86788	1 Lámpara PAR30	Aluminio	37	E27	175 x 175 x 167	460	Negro	8
86771	1 Lámpara PAR30	Aluminio	37	E27	175 x 175 x 167	460	Blanco	8
86766	2 Lámparas PAR30	Aluminio	37	E27	325 x 175 x 167	820	Negro	6
86772	2 Lámparas PAR30	Aluminio	37	E27	325 x 175 x 167	820	Blanco	6
86767	3 Lámparas PAR 30	Aluminio	37	E27	471 x 175 x 167	1240	Negro	6
86773	3 Lámparas PAR 30	Aluminio	37	E27	471 x 175 x 167	1240	Blanco	6
86789	1 Lámpara AR111	Aluminio	14	GU10	175 x 175 x 45	290	Negro	10
86768	1 Lámpara AR111	Aluminio	14	GU10	175 x 175 x 45	290	Blanco	10
86790	2 Lámparas AR111	Aluminio	14	GU10	325 x 175 x 45	540	Negro	10
86769	2 Lámparas AR111	Aluminio	14	GU10	325 x 175 x 45	540	Blanco	10
86791	3 Lámparas AR111	Aluminio	14	GU10	471 x 175 x 45	730	Negro	8
86770	3 Lámparas AR111	Aluminio	14	GU10	471 x 175 x 45	730	Blanco	8

PAR30 E27

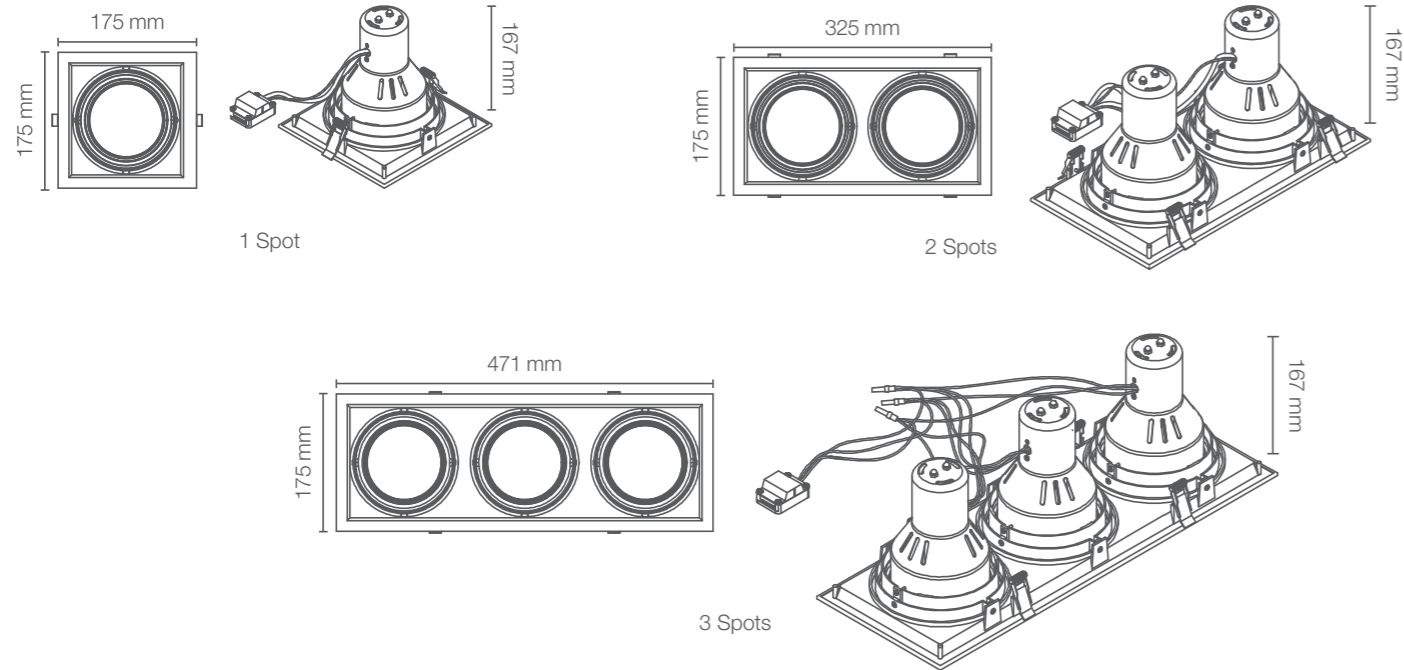

AR111 GU10

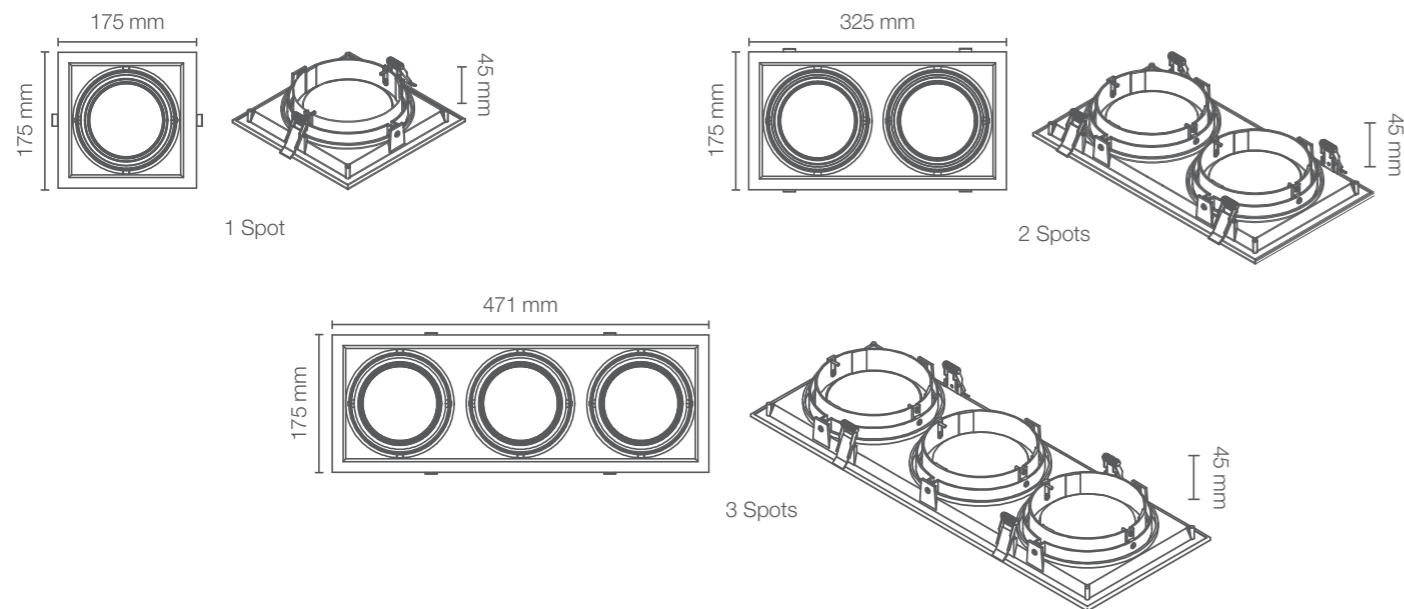

LEDVANCE® EMERGENCY LIGHT 2X1W

A la hora de iluminar un pasillo o un área de tránsito, es primordial tener en cuenta la implementación de sistemas de emergencia que brinden las condiciones adecuadas de orientación, visibilidad y seguridad ante cortes de energía o siniestros. Esta nueva luminaria de emergencia incorpora un diseño robusto en materiales de alta resistencia autoextinguibles en caso de exposición al fuego, cuenta con 2 cabezales LED ajustables ultrabrillantes que permiten direccionar la iluminación para un máximo aprovechamiento. Su batería integrada de Níquel-Cadmio le permitirá un funcionamiento mínimo de 90 minutos de respaldo.

When lighting a corridor or a traffic area, it is essential to take into account the implementation of emergency systems that provide adequate orientation, visibility and safety conditions in the event of power outages or accidents. This new emergency luminaire incorporates a robust design in self-extinguishing high-resistance materials in case of fire exposure, it has 2 ultra-bright adjustable LED heads that allow directing the lighting for maximum use. Its built-in Nickel-Cadmium battery will allow a minimum 90-minute backup operation.



APLICACIONES / APPLICATIONS



Código Sku	Potencia Power (W)	Flujo Luminoso Luminous Flux (lm)	Ángulo de Apertura Opening Angle	Temp. de Color Color Temp. (K)	IRC CRI	Vida Útil Life (h)	Dimensiones Dimensions (mm)	Color de Producto Product Color	Unidades por Caja Units per box
88687	2	200	110°	6 500	> 70	30 000	280 x 110 x 67.5	Blanco	6

INDUSTRIAL





LEDVANCE® HIGHBAY 220 V

Luminaria compacta con estructura de aluminio y vidrio templado que garantiza alta protección IP e IK. Ideal para iluminar espacios entre 12 y 15 metros de altura. Cuenta con protección contra sobretensiones de 4kV y ángulo de apertura de 105° que le brindará una excelente distribución de luz.

Compact luminaire with aluminum and tempered glass structure that guarantees high IP and IK protection. Ideal for lighting spaces between 12 and 15 meters high. It has 4kV SPD and 105° beam angle that will provide excellent light distribution.



- HASTA 60% DE AHORRO DE ENERGÍA**
- 3 AÑOS DE GARANTÍA**
- 220 - 240 V~**
- IP65**
- IK06**
- PROTECCIÓN CONTRA SOBRETENSIONES 4kV**

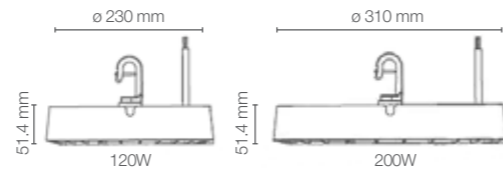

APLICACIONES / APPLICATIONS



Código Sku	Potencia Power (W)	Equivalencia Equivalence AM (W)	Flujo Luminoso Luminous Flux (lm)	Ángulo de Apertura Opening Angle	Temp. de Color Color Temp. (K)	IRC CRI	Vida Útil Life (h)	Dimensiones Dimensions (mm)	Color de Producto Product Color	Unidades por Caja Units per box
80524	120	1 x 250	12 000	105°	6500	>80	30 000	Ø 230 x 51.4	Negro Mate	1
80525	200	1 x 400	18 000	105°	6500	>80	30 000	Ø 310 x 51.4	Negro Mate	1

LEDVANCE® HIGHBAY PERFORMANCE

HIGHBAY PERFORMANCE de LEDVANCE integra un diseño moderno con estructura de aluminio fundido y difusor de policarbonato de alta resistencia siendo ahora más ligero, pero manteniendo la rigidez de antes, tiene un alto desempeño de 140 lm/W y cuenta con protección contra sobre tensiones de 4kV además de disponer de atenuación 0-10V ofreciéndole eficacia, seguridad y ahorro en un solo producto.

HIGHBAY PERFORMANCE by LEDVANCE integrates a modern design with a cast aluminum structure and a high-resistance polycarbonate diffuser being now lighter, but maintaining the rigidity of before, it has a high performance of 140 lm/W and it has surge protection of 4kV in addition to having 0-10V dimming offering efficiency, safety and savings in a single product.



- HASTA 60% DE AHORRO DE ENERGÍA**
- 5 AÑOS DE GARANTÍA**
- 100 - 277 V~**
- IP65**
- IK08**
- 0-10V ATENUABLE**
- 4kV**

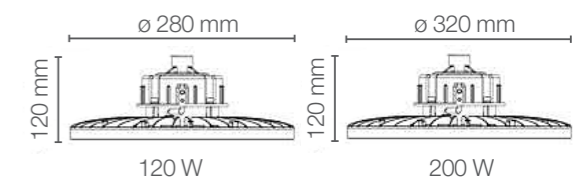

APLICACIONES / APPLICATIONS



Código Sku	Potencia Power (W)	Equivalencia Equivalence AM (W)	Flujo Luminoso Luminous Flux (lm)	Ángulo de Apertura Opening Angle	Temp. de Color Color Temp. (K)	IRC CRI	Vida Útil Life (h)	Dimensiones Dimensions (mm)	Color de Producto Product Color	Unidades por Caja Units per box
80604	120	1 x 250	16 800	110°	5700	>80	50 000	Ø280x120	Negro Mate	1
80600	120	1 x 250	16 800	110°	6500	>80	50 000	Ø280x120	Negro Mate	1
80605	200	1 x 400	28 000	110°	5700	>80	50 000	Ø320x120	Negro Mate	1
80601	200	1 x 400	28 000	110°	6500	>80	50 000	Ø320x120	Negro Mate	1
								Accesorios* Accessories*	80665	HB PFM BRACKET 120W
									80635	HB PFM BRACKET 200W

* En sustitución de lámparas de aditivos metálicos / In the replacement of metal halide lamps.

* Se venden por separado / They are sold separately.

* En sustitución de lámparas de aditivos metálicos / In the replacement of metal halide lamps.



LEDVANCE® FLOODLIGHT HIGH WATTAGE PERFORMANCE

Reflector de LED de alta potencia para iluminación de exteriores. Instalación fácil y rápida.

LED reflector for outdoor lighting. Easy and fast installing.

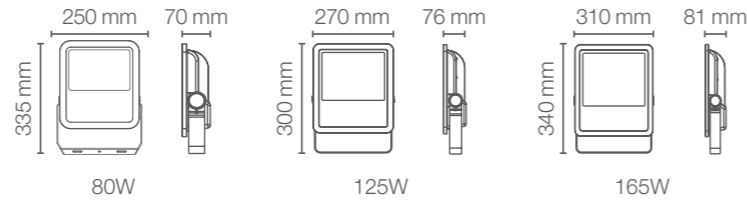

APLICACIONES / APPLICATIONS



Código Sku	Potencia Power (W)	Equivalencia Equivalence AM (W)	Flujo Luminoso Luminous Flux (lm)	Ángulo de Apertura Opening Angle	Tensión Tension (V~)	Temp. de Color Color Temp. (K)	IRC CRI	Vida Útil Life (h)	Dimensiones Dimensions (mm)	Color de Producto Product Color	Unidades por Caja Units per box
80650	80	1 x 175	10 000	100°	100-277	5000	>80	50 000	250 x 55 x 335	Negro	1
80652	125	1 x 250	15 000	100°	100-277	5000	>80	50 000	290 x 59 x 381	Negro	1
80654	165	1 x 400	20 000	100°	100-277	5000	>80	50 000	322 x 60 x 418	Negro	1

* En sustitución de lámparas de aditivos metálicos / In the replacement of metal halide lamps.

LEDVANCE® FLOODLIGHT HIGH POWER

FLOODLIGHT de alto rendimiento, alta reproducción de color y con protección contra sobretensiones de 6kV, adecuada para aplicaciones en espacios amplios. Disponible en versiones de 300W, 400W y 600W con 2 ángulos de apertura 30° y 60°.

FLOODLIGHT high performance, high color reproduction and 6 000 V surge protection, suitable for applications in large spaces. Available in 300W, 400W and 600W versions and two opening angles 30° and 60°.



APLICACIONES / APPLICATIONS



Código Sku	Potencia Power (W)	Equivalencia Equivalence AM (W)	Flujo Luminoso Luminous Flux (lm)	Ángulo de Apertura Opening Angle	Temp. de Color Color Temp. (K)	IRC CRI	Vida Útil Life (h)	Dimensiones Dimensions (mm)	Color de Producto Product Color	Unidades por Caja Units per box
86798	300	1 x 600	36000	30°	5700	>80	50 000	522X152X370	Negro	1
86799	400	1 X 750	48000	30°	5700	>80	50 000	522X152X466	Negro	1
86801	600	1 X 1000	72000	30°	5700	>80	50 000	575X152X700	Negro	1
86742	300	1 x 600	36000	60°	5700	>80	50 000	522X152X370	Negro	1
86743	400	1 X 750	48000	60°	5700	>80	50 000	522X152X466	Negro	1
86745	600	1 X 1000	72000	60°	5700	>80	50 000	575X152X700	Negro	1

* En sustitución de lámparas de aditivos metálicos / In the replacement of metal halide lamps.

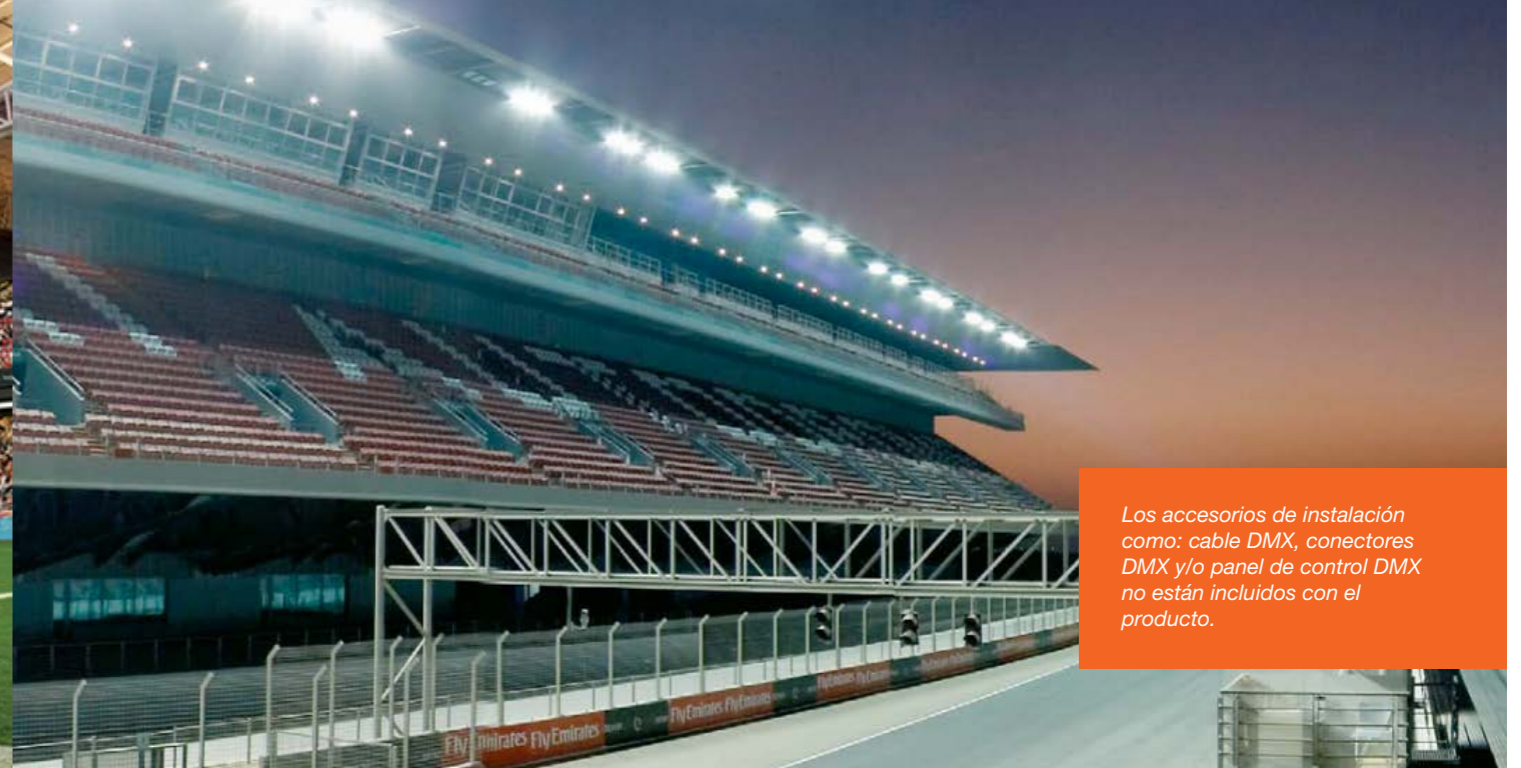

Los accesorios de instalación como: cable DMX, conectores DMX y/o panel de control DMX no están incluidos con el producto.

LEDVANCE® FLOODLIGHT HIGH POWER 1KW / 1.5KW

Potentes reflectores de 1 000W y 1 500W con lente de policarbonato, brazo ajustable de 240° y acabado en inyección de aluminio resistente a radiación UV. Con una eficacia de 120 lm/W, tres diferentes ángulos de apertura, atenuable y además protección contra sobretensiones de 10kV. Seguridad y ahorro de energía en un solo producto.

Powerful 1,000W and 1,500W reflectors with polycarbonate lens, 240° adjustable arm and UV-resistant aluminum injection finish. With an efficiency of 120 lm/W, three different opening angles, attenuatable and also 10kV surge protection. Safety and energy savings in a single product.



- 5 AÑOS DE GARANTÍA
- 0-10V ATENUABLE
- PROTECCIÓN CONTRA SOBRETENSIONES 10kV
- SOPORTE ROTATIVO 240°
- IP66
- IK08

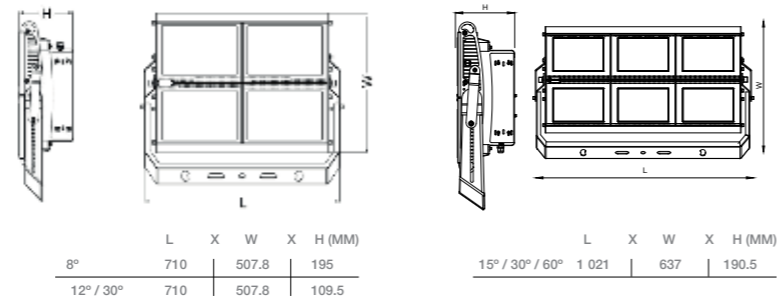

APLICACIONES / APPLICATIONS



Código Sku	Potencia Power (W)	Flujo Luminoso Luminous Flux (lm)	Ángulo de Apertura Opening Angle	Temp. de Color Color Temp. (K)	IRC CRI	Vida Útil Life (h)	Dimensiones Dimensions (mm)	Color de Producto Product Color	Unidades por Caja Units per box
80366	1 000	120 000	8°	5700	>80	50 000	710X507.8X195	Gris	1
80367	1 000	120 000	12°	5700	>80	50 000	710X507.8X109.5	Gris	1
80368	1 000	120 000	30°	5700	>80	50 000	710X507.8X109.5	Gris	1
80939*	1 500	180 000	15°	5700	>80	50 000	1021x637x190.5	Gris	1
80941*	1 500	180 000	30°	5700	>80	50 000	1021x637x190.5	Gris	1
80942*	1 500	180 000	60°	5700	>80	50 000	1021x637x190.5	Gris	1

*Producto bajo pedido / Make to order product.

LEDVANCE® FLOODLIGHT HIGH POWER 1KW DMX

Obtén todas las bondades de FLOODLIGHT HP 1KW y complementa con toda la dinámica que ofrece el protocolo de control DMX 512. Implementa conectividad y rendimiento a tus proyectos, controlando y regulando la intensidad de luz, creando escenas y programaciones especiales para espectáculos o grandes eventos.

Get all the benefits of FLOODLIGHT HP 1KW and complement all the dynamics offered by the DMX 512 control protocol. Implement connectivity and performance to your projects, controlling and regulating the intensity of light, creating scenes and special settings for shows or big events.



- 5 AÑOS DE GARANTÍA
- ATENUABLE
- PROTECCIÓN CONTRA SOBRETENSIONES 10kV
- DMX
- IP66
- IK08

APLICACIONES / APPLICATIONS

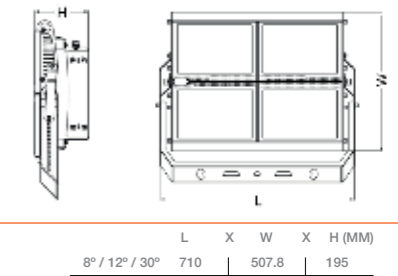

Código Sku	Potencia Power (W)	Flujo Luminoso Luminous Flux (lm)	Ángulo de Apertura Opening Angle	Temp. de Color Color Temp. (K)	IRC CRI	Vida Útil Life (h)	Dimensiones Dimensions (mm)	Color de Producto Product Color	Unidades por Caja Units per box
88688*	1 000	120 000	8°	5700	>80	50 000	710 x 507.8 x 195	Gris	1
88689*	1 000	120 000	12°	5700	>80	50 000	710 x 507.8 x 195	Gris	1
88690*	1 000	120 000	30°	5700	>80	50 000	710 x 507.8 x 195	Gris	1

*Producto bajo pedido / Make to order product.



LEDVANCE® DAMP PROOF HOUSING

Luminaria diseñada para tubos LED T5 y T8 de 120 cm. Brinda protección contra el ingreso de líquidos y polvo gracias al sellado hermético que proporcionan sus clips laterales, además de un alto grado de protección contra impactos mecánicos debido a su fabricación en ABS y Policarbonato, polímeros de alta resistencia a impactos mecánicos y altas temperaturas.

Luminaire designed for T5 and T8 LED tubes in 120 cm version. Provides protection against ingress of liquids and dust thanks to the hermetic sealing provided by its side clips, in addition to a high degree of protection against mechanical impacts due to its manufacture in ABS and Polycarbonate, polymers of high resistance to mechanical impacts and high temperatures.



3 AÑOS DE GARANTÍA
COMPATIBLE CON TUBOS LED NO INCLUIDOS
VERSIÓN PARA 1 o 2 LÁMPARAS
100 - 277 V ~
IP65
IK08

CLIPS EN PC ALTA DURABILIDAD
DIRIGIDA EN POLICARBONATO



APLICACIONES / APPLICATIONS



Código Sku	Versión	Material	Potencia Max. Max. Power (W)	Dimensiones Dimensions (mm)	Peso Weight (g)	Color de Producto Product Color	Unidades por Caja Units per box
80462	1 Lámpara	Plástico / Policarbonato	1 x 20	1261x69x64	710	Gris	8
80961	2 Lámparas	Plástico / Policarbonato	2 x 16	1261x107x70	1 092	Gris	6

LEDVANCE® DAMP PROOF LED

Nuestra línea de luminarias LED a prueba de vapor cuenta con nueva imagen y ha reforzado su grado de protección IP con clips de seguridad de acero inoxidable. Ahora encuentre su DAMP PROOF LED en 18W, 40W y 58W con mayor desempeño de 120 lm/W y mayor ángulo de apertura.

Our waterproof LED luminaires has a new look, IP protection has been reinforced with stainless steel safety clips. Now find your DAMP PROOF LED in 18W, 40W, and 58W with higher performance than 120 lm/W and greater opening angle.



HASTA 50% DE AHORRO DE ENERGÍA
3 AÑOS DE GARANTÍA
100 - 277 V ~
IP65
IK08

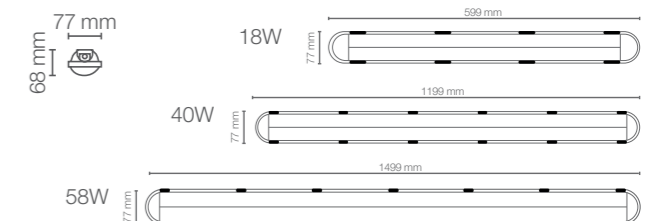

APLICACIONES / APPLICATIONS



Código Sku	Potencia Power (W)	Equivalencia Equivalence Fluor. T8 (W)	Flujo Luminoso Luminous Flux (lm)	Ángulo de Apertura Opening Angle	Temp. de Color Color Temp. (K)	IRC CRI	Vida Útil Life (h)	Dimensiones Dimensions (mm)	Color de Producto Product Color	Unidades por Caja Units per box
80567	18	2 x 14 T5 ó 2 x 17 T8	2 160	115°	○ 4000	>80	30 000	599 x 77 x 68	Gris	6
80568	18	2 x 14 T5 ó 2 x 17 T8	2 160	115°	● 6500	>80	30 000	599 x 77 x 68	Gris	6
80571	40	2 X 28 T5 ó 2 x 32 T8	4 800	115°	○ 4000	>80	30 000	1199 x 77 x 68	Gris	6
80572	40	2 X 28 T5 ó 2 x 32 T8	4 800	115°	● 6500	>80	30 000	1199 x 77 x 68	Gris	6
80575	58	2 x 54 T5 ó 2 x 59 T8	6 960	115°	○ 4000	>80	50 000	1499 x 77 x 68	Gris	6
80576	58	2 x 54 T5 ó 2 x 59 T8	6 960	115°	● 6500	>80	50 000	1499 x 77 x 68	Gris	6

* En sustitución de lámparas fluorescentes tubulares. / In replacement of tubular fluorescent lamps.



LEDVANCE® DAMP PROOF EMERGENCY DRIVER

Nueva versión de luminaria LED a prueba de vapor con Sistema de Emergencia que permite utilizar la luminaria de manera habitual y a su vez contar con una iluminación de respaldo de hasta 180 minutos garantizando la seguridad de los usuarios cuando exista un corte en el suministro de energía.

New version of waterproof LED luminaire with Emergency System that allows the luminaire to be used regularly and at the same time have back-up lighting of up to 180 minutes warranting the safety of users when there is a cut in the power supply.



- 100 - 277 V~
- IP65
- 3 AÑOS DE GARANTÍA
- IK08
- 600 lm DE ILUMINACIÓN EMERGENCIA
- CARGA DE BATERÍA EN 24h



APLICACIONES / APPLICATIONS



Código Sku	Potencia Power (W)	Equivalencia Equivalence Fluor. T8(W)	Flujo Luminoso Luminous Flux (lm)	Ángulo de Apertura Opening Angle	Temp. de Color Color Temp. (K)	IRC CRI	Vida Útil Life (h)	Dimensiones Dimensions (mm)	Color de Producto Product Color	Unidades por Caja Units per box
88569	43	2 x 32 T8	4 773	115°	4000	>80	30 000	1199 x 77 x 68	Gris	6
80355	42	2 x 32 T8	4 800	115°	6500	>80	30 000	1199 x 77 x 68	Gris	6
80356	60	2 x 59 T8	6 960	115°	4000	>80	30 000	1499 x 77 x 68	Gris	6
80357	60	2 x 59 T8	6 960	115°	6500	>80	30 000	1499 x 77 x 68	Gris	6

* En sustitución de lámparas fluorescentes tubulares / In replacement of tubular fluorescent lamps.

LEDVANCE® DAMP PROOF SENSOR

Luminaria para uso consciente de energía debido al ahorro proporcionado por el sensor de presencia y su temporizador integrado. Su instalación es simple y no requiere sistemas adicionales.

Luminaire for an energy conscious consumption thanks due to the savings provided by the presence sensor and its integrated timer. Its installation is simple and does not require additional systems.

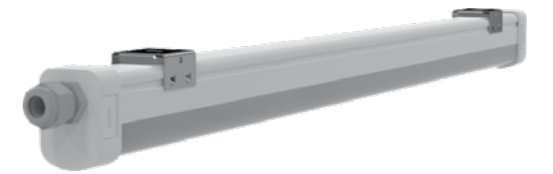

- HASTA 50% DE AHORRO DE ENERGÍA
- 3 AÑOS DE GARANTÍA
- 100 - 277 V~
- IP65
- FOTOCELDA ACTIVA
- TEMPORIZADOR 60 SEG
- DISTANCIA 3 m
- SENSOR NO PROGRAMABLE

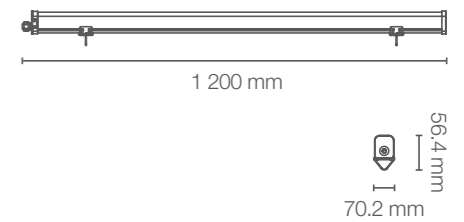

APLICACIONES / APPLICATIONS



Código Sku	Potencia Power (W)	Equivalencia Equivalence Fluor. (W)	Flujo Luminoso Luminous Flux (lm)	Ángulo de Apertura Opening Angle	Temp. de Color Color Temp. (K)	IRC CRI	Vida Útil Life (h)	Dimensiones Dimensions (mm)	Color de Producto Product Color	Unidades por Caja Units per box
86792	30	2 x 32 T8	3 300	100°	6500	>80	30 000	1200 x 56.4 x 70.2	Blanco	6

* En sustitución de lámparas fluorescentes tubulares / In replacement of tubular fluorescent lamps.



EXTERIOR

LEDVANCE® WALL PACK

Luminaria para sobreponer en muro, con estructura de aluminio extruido resistente a impactos mecánicos de grado IK08, y para aplicaciones exteriores gracias a la hermeticidad que le brinda su IP65. Adquiera la iluminación ideal de acuerdo a sus necesidades gracias a la atenuación que le permite el controlador de la luminaria, así como también le brinda un rendimiento de hasta 130 lm/W.

Surface mounted aluminum luminaire for external application due the high resistant IP/IK. Acquire the ideal lighting according to your needs thanks to the dimming allowed by the luminaire controller, as well as giving you a performance of up to 130 lm/W.



-
-
-
-
-
-
-
-

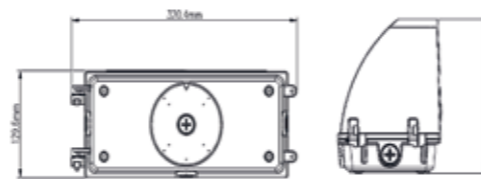

APLICACIONES / APPLICATIONS



Código Sku	Potencia Power (W)	Equivalencia Equivalence AM (W)	Flujo Luminoso Luminous Flux (lm)	Ángulo de Apertura Opening Angle	Temp. de Color Color Temp. (K)	IRC CRI	Vida Útil Life (h)	Dimensiones Dimensions (mm)	Color de Producto Product Color	Unidades por Caja Units per box
80434	45	250	5850	110°	○ 4000	>80	50 000	320.4X129.6X174.2	Gris Oscuro	4
80435	45	250	5850	110°	● 6500	>80	50 000	320.4X129.6X174.2	Gris Oscuro	4
80436	70	400	9100	110°	○ 4000	>80	50 000	320.4X129.6X174.2	Gris Oscuro	4
80437	70	400	9100	110°	● 6500	>80	50 000	320.4X129.6X174.2	Gris Oscuro	4

* En sustitución de lámparas de aditivos metálicos / In the replacement of metal halide lamps.



LEDVANCE® SPIKE

La nueva línea de luminarias para jardín de LEDVANCE combina calidad y confianza, dos aspectos decisivos para la aplicación en exteriores. Con alta resistencia y durabilidad, la línea LEDVANCE SPIKE está especialmente diseñada para resistir en áreas externas con grado de protección IP67 e IK08.

The new line LEDVANCE SPIKE combines quality and reliability, two decisive aspects for outdoor applications. With high strength and durability, these luminaires is specially designed to resist in external areas with high index protection IP67 and IK08.

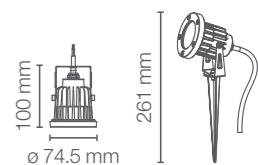

APLICACIONES / APPLICATIONS

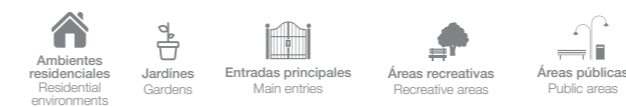

Código Sku	Potencia Power (W)	Equivalencia Equivalence Halógena (W)	Flujo Luminoso Luminous Flux (lm)	Ángulo de Apertura Opening Angle	Temp. de Color Color Temp. (K)	IRC CRI	Vida Útil Life (h)	Dimensiones Dimensions (mm)	Color de Producto Product Color	Unidades por Caja Units per box
86634	5	45	350	24°	3000	>80	15 000	Ø 74.50 x 261	Negro	30
86635	5	45	350	24°	5000	>80	15 000	Ø 74.50 x 261	Negro	30
86642	9	65	720	30°	3000	>80	15 000	Ø 74.50 x 261	Negro	30
86643	9	65	720	30°	5000	>80	15 000	Ø 74.50 x 261	Negro	30

* En sustitución de lámparas halógenas convencionales / In the replacement of conventional halogen lamps.



LEDVANCE® UPLIGHT

Luminarias de LED integrado empotrables en piso, ideal para destacar cualquier tipo de espacio a través de su iluminación de alta eficacia y su ángulo de apertura de 20°. Su elegante diseño facilita integrarlo a la arquitectura de cualquier espacio urbano e incluso residencial, siendo un complemento perfecto para el paisajismo del lugar.

Embed floor LED luminaires, ideal for highlighting any type of space through its high efficiency lighting and 20° opening angle. Its elegant design makes it easy to integrate it into the architecture of any urban and even residential space, being a perfect complement to the landscaping of the place.



HASTA 80% DE AHORRO DE ENERGÍA | 3 AÑOS DE GARANTÍA | 100 - 240V~ | IP67 | IK10

APLICACIONES / APPLICATIONS

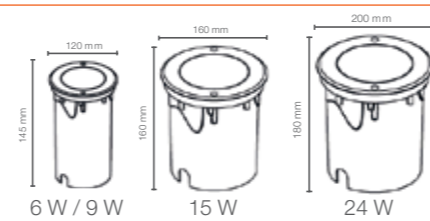

Código Sku	Potencia Power (W)	Equivalencia Equivalence (W)	Flujo Luminoso Luminous Flux (lm)	Ángulo de Apertura Opening Angle	Temp. de Colo Color Temp. (K)	IRC CRI	Vida Útil Life (h)	Dimensiones Dimensions (mm)	Color de Producto Product Color	Unidades por Caja Units per box
80876	6	1 X 50*	480	20°	3 000	>70	30 000	Ø120 x 145	Gris	8
80877	6	1 X 50*	480	20°	5 000	>70	30 000	Ø120 x 145	Gris	8
80879	9	1 X 75*	810	20°	3 000	>70	30 000	Ø120 x 145	Gris	4
80881	9	1 X 75*	810	20°	5 000	>70	30 000	Ø120 x 145	Gris	4
80882	15	1 X 100*	1 500	20°	3 000	>70	30 000	Ø160 x 160	Gris	4
80883	15	1 X 100*	1 500	20°	5 000	>70	30 000	Ø160 x 160	Gris	4
80885	24	1 x 35**	2 400	20°	3 000	>70	30 000	Ø200 x 180	Gris	4
80887	24	1 x 35**	2 400	20°	5 000	>70	30 000	Ø200 x 180	Gris	4

* En sustitución de lámparas halógenas convencionales / In the replacement of conventional halogen lamps.

**En sustitución de lámparas de aditivos metálicos cerámicos / In the replacement of ceramic metal halide lamps.



LEDVANCE® WALL LIGHT APLIQUE SINGLE & DUAL HOUSING

Luminarias decorativas para uso interior y exterior en versión housing.

Gracias a su base GU10 integrada se logra una combinación de APLIQUE + Lámpara PAR16 posibilitando aplicaciones con diferentes temperaturas de color (Luz Cálida, Blanco Frío, Luz de Día o hasta RGB).

Decorative luminaires for indoor and outdoor use in housing.

Thanks to its integrated GU10 base, a combination of APLIQUE + PAR16 lamp is achieved, enabling applications with different color temperatures (Warm Light, Cool Light, Day Light or even RGB light).



2 COLORES coloris | SINGLE | DUAL | 3 AÑOS DE GARANTÍA | LÁMPARA NO INCLUIDA | GU10 | IP54 | DISEÑO COMPACTO

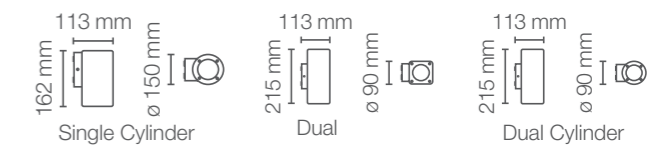

APLICACIONES / APPLICATIONS

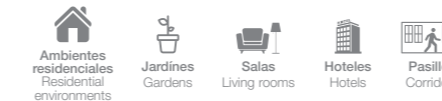

Compatible con nuestra línea de lámparas LED SUPERSTAR PAR16.

Código Sku	Versión	Material	Potencia Max. Max. Power (W)	Base	Dimensiones Dimensions (mm)	Peso Weight (g)	Color de Producto Product Color	Unidades por caja Units per box
86600	Single Cylinder	Policarbonato	1 x 11	GU10	90 x 113 x 162	413	Negro	16
86601	Single Cylinder	Policarbonato	1 x 11	GU10	90 x 113 x 162	413	Blanco	16
86596	Dual	Policarbonato	2 x 11	GU10	90 x 113 x 215	558	Negro	16
86597	Dual	Policarbonato	2 x 11	GU10	90 x 113 x 215	558	Blanco	16
86599	Dual Cylinder	Policarbonato	2 x 11	GU10	90 x 113 x 215	498	Negro	16
86598	Dual Cylinder	Policarbonato	2 x 11	GU10	90 x 113 x 215	498	Blanco	16



LEDVANCE® WALL LIGHT DECOLED

Luminarias decorativas para uso interior y exterior en versión led integrado.

Decorative luminaires for indoor and outdoor use in integrated LED version.



APLICACIONES / APPLICATIONS

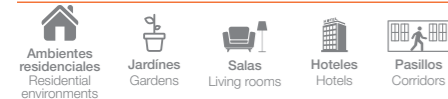

Código Sku	Versión	Potencia Power (W)	Flujo Luminoso Luminous Flux (lm)	Ángulo de Apertura Opening Angle	Temp. de Color Color Temp. (K)	IRC CRI	Vida Útil Life (h)	Dimensiones Dimensions (mm)	Color de Producto Product Color	Unidades por caja Units per box
86610	Circular	3	150	110°	3000	>80	30 000	∅ 150 x 27	Negro	24
86608	Quarter	3	150	110°	3000	>80	30 000	125 x 125 x 27	Negro	24
86609	Quarter	3	150	110°	3000	>80	30 000	125 x 125 x 27	Blanco	24
86604	Signal	4	180	110°	3000	>80	30 000	230 x 80 x 27	Negro	24
86605	Signal	4	180	110°	3000	>80	30 000	230 x 80 x 27	Blanco	24
86606	Vertical	1	30	140°	3000	>80	30 000	80 x 200 x 27	Negro	24
86607	Vertical	1	30	140°	3000	>80	30 000	80 x 200 x 27	Blanco	24
86612	Balyza	1.5	70	160°	3000	>80	30 000	100 x 60 x 33	Negro	24
86613	Balyza	1.5	70	160°	3000	>80	30 000	100 x 60 x 33	Blanco	24
86689	Balyza Quarter	3	100	112°	3000	>80	30 000	120 x 120 x 32	Negro	24
86692	Balyza Circular	3	100	104°	3000	>80	30 000	∅ 135 x 32	Blanco	24

LEDVANCE® ENDURA

Elegante línea decorativa de luminarias LED para uso interior y exterior con diseño sofisticado.

Elegant decorative line of LED luminaires for indoor and outdoor use with sophisticated design.

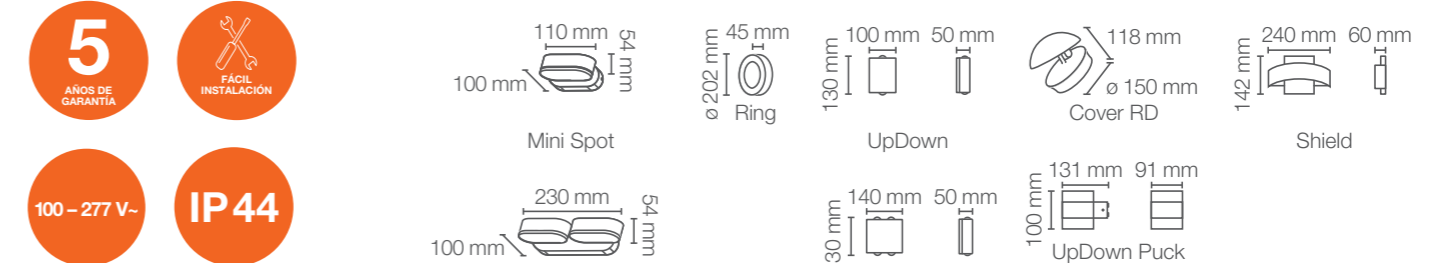

APLICACIONES / APPLICATIONS

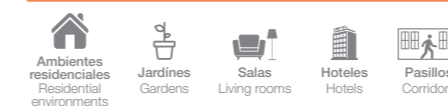

Código Sku	Versión	Potencia Power (W)	Flujo Luminoso Luminous Flux (lm)	Ángulo de Apertura Opening Angle	Temp. de Color Color temp. (K)	IRC CRI	Vida Útil Life (h)	Dimensiones Dimensions (mm)	Color de Producto Product Color	Unidades por caja Units per box
86866	UpDown Deco I	6	280	40°	3000	>80	30 000	130 x 100 x 50	Gris Oscuro	6
86867	UpDown Deco II	11	550	40°	3000	>80	30 000	130 x 140 x 50	Gris Oscuro	6
86868	UpDown Puck	13	980	120°	3000	>80	30 000	131 x 110 x 91	Gris Oscuro	6
86876	Ring	13	500	100°	3000	>80	30 000	∅ 202 x 45	Gris Oscuro	6
86878	Mini Spot I	8	320	100°	3000	>80	30 000	100 x 110 x 54	Gris Oscuro	6
86879	Mini Spot II	13	800	100°	3000	>80	30 000	100 x 230 x 54	Gris Oscuro	6
86880	Cover RD	13	640	100°	3000	>80	30 000	∅ 150 x 142	Gris Oscuro	4
86881	Cover RD	13	640	100°	3000	>80	30 000	∅ 150 x 142	Blanco	4
86883	Shield SQ	11	400	340°	3000	>80	30 000	142 x 240 x 60	Gris Oscuro	6



LEDVANCE® FLOODLIGHT LOW WATTAGE

Reflector de LED para iluminación de exteriores, elaborado con materiales de alta calidad, resistente a chorros de agua, lluvia y polvo. Tiene un diseño compacto y moderno, difusor en vidrio templado esmerilado antirreflejante. Disponible en temperaturas de color: Luz Cálida (3000 K) y Blanco Frío (5000 K).

LED reflector for outdoor lighting, made with high quality materials, resistant to waterjets, rain and dust. It has a compact and modern design, anti-glare frosted tempered glass diffuser. Available in Warm Light temperature (3000 K) and Cool Light (5000 K) versions.



APLICACIONES / APPLICATIONS



Código Sku	Potencia Power (W)	Equivalencia Halógena (W)	Flujo Luminoso Luminous Flux (lm)	Ángulo de Apertura Opening Angle	Temp. de Color Color Temp. (K)	IRC CRI	Vida Útil Life (h)	Dimensiones Dimensions (mm)	Color de Producto Product Color	Unidades por Caja Units per box
80633	10	1 x 100 Hal.	1100	100°	3000	>80	50 000	122 x 131 x 36	Negro	12
80634	10	1 x 100 Hal.	1200	100°	5000	>80	50 000	122 x 131 x 36	Negro	12
80641	10	1 x 100 Hal.	1100	100°	3000	>80	50 000	122 x 131 x 36	Blanco	12
80642	10	1 x 100 Hal.	1 200	100°	5000	>80	50 000	122 x 131 x 36	Blanco	12
80637	30	1 x 250 Hal.	3 300	100°	3000	>80	50 000	177 x 186 x 42	Negro	8
80638	30	1 x 250 Hal.	3 600	100°	5000	>80	50 000	177 x 186 x 42	Negro	8
80645	30	1 x 250 Hal.	3 300	100°	3000	>80	50 000	177 x 186 x 42	Blanco	8
80646	30	1 x 250 Hal.	3 600	100°	5000	>80	50 000	177 x 186 x 42	Blanco	8
80639	50	1 x 500 Hal.	5 500	100°	3000	>80	50 000	206 x 218 x 46	Negro	8
80640	50	1 x 500 Hal.	6 000	100°	5000	>80	50 000	206 x 218 x 46	Negro	8
80647	50	1 x 500 Hal.	5 500	100°	3000	>80	50 000	206 x 218 x 46	Blanco	8
80648	50	1 x 500 Hal.	6 000	100°	5000	>80	50 000	206 x 218 x 46	Blanco	8

* En sustitución de lámparas halógenas convencionales / In the replacement of conventional halogen lamps.

LEDVANCE® FLOODLIGHT SENSOR PERFORMANCE

Descubra todas las bondades que la nueva generación de FLOODLIGHT SENSOR ofrece, este compacto reflector cuenta con una alta eficacia de hasta 120 lm/W y le brinda la libertad de ajustar la configuración del sensor de acuerdo a sus necesidades, ajuste la distancia de detección de 4 a 12 m para términos de detección de movimiento, complemente su configuración con el sensor de luz, el cual permitirá encendidos y apagados automáticos cuando haya bajos o altos niveles de iluminación en el entorno y finalmente ajuste el temporizador de apagado desde 10 segundos hasta 2 minutos.

Discover all the benefits that the new generation of FLOODLIGHT SENSOR offers, this compact reflector has a high efficiency of up to 120 lm / W and gives you the freedom to adjust the sensor settings according to your needs, adjust the detection distance of 4 to 12 m for motion detection terms, complement your configuration with the light sensor, which will allow automatic on and off when there are low or high levels of lighting in the environment and finally set the off timer from 10 seconds to 2 minutes.

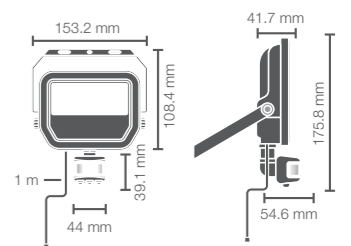
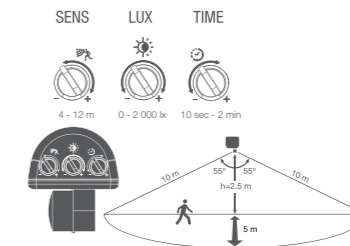

APLICACIONES / APPLICATIONS



Código Sku	Potencia Power (W)	Equivalencia Halógena (W)	Flujo Luminoso Luminous Flux (lm)	Ángulo de Apertura Opening Angle	Temp. de Color Color Temp. (K)	IRC CRI	Vida Útil Life (h)	Dimensiones Dimensions (mm)	Color de Producto Product Color	Unidades por Caja Units per box
80643	20	1 x 160 Hal.	2 200	100°	3000	>80	50 000	145 x 42 x 156	Negro	12
80644	20	1 x 160 Hal.	2 400	100°	5000	>80	50 000	145 x 42 x 156	Negro	12

* En sustitución de lámparas halógenas convencionales / In the replacement of conventional halogen lamps.



Compatible con nuestra fotocelda de tres pines 85204

LEDVANCE® AREALIGHT

Luminaria con acabado en aluminio, diseño moderno e índice de protección IP66. Es la mejor opción para iluminar áreas residenciales y exteriores.

Luminaire with aluminum finish, modern design and high index protection. It is the best option to illuminate residential and exterior areas.



- HASTA 50% DE AHORRO DE ENERGÍA
- 5 AÑOS DE GARANTÍA
- 100 - 240 V~
- IP66
- IK08
- 10kV

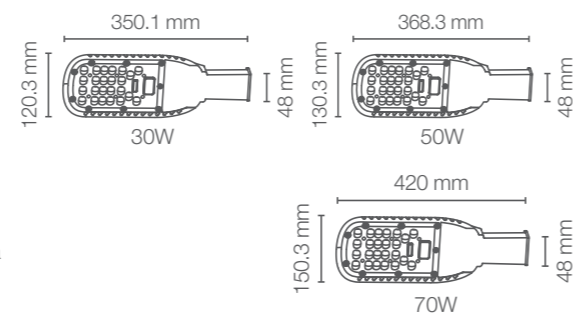

APLICACIONES / APPLICATIONS



Código Sku	Potencia Power (W)	Equivalencia Equivalence SHP (W)	Flujo Luminoso Luminous Flux (lm)	Ángulo de Apertura Opening Angle	Temp. de Color Color Temp. (K)	IRC CRI	Vida Útil Life (h)	Dimensiones Dimensions (mm)	Color de Producto Product Color	Unidades por Caja Units per box
86824	50	100	5000	135 x 75°	● 6500	>80	50 000	368.3 x 130.3 x 48	Gris	10
86825	70	150	7000	135 x 75°	● 6500	>80	50 000	420 x 150.3 x 48	Gris	8
86826	30	70	3000	135 x 75°	○ 4000	>80	50 000	350.1 x 120.3 x 48	Gris	10
86827	50	100	5000	135 x 75°	○ 4000	>80	50 000	368.3 x 130.3 x 48	Gris	10

*En sustitución de lámparas de sodio de alta presión / In the replacement of sodium high pressure lamps.

LEDVANCE® URBANA

Luminaria LED para punta de poste decorativa con alta reproducción de color y alto índice de protección. Cuenta con receptáculo que permite la interconexión con sistemas de telegestión. Cubre las necesidades lumínicas con el manejo de sombras, colores y contrastes tratando la iluminación como un arte.

LED luminaire for decorative pole tip with high color reproduction and high protection index. It has a receptacle that allows interconnection with remote management systems. It covers the light needs with the handling of shadows, colors and contrasts treating lighting as an art.



incluye adaptador para fotocelda
photocell adapter included

- HASTA 40% DE AHORRO DE ENERGÍA
- 5 AÑOS DE GARANTÍA
- 120 - 277 V~
- IP66
- 1 10V ATENUABLE
- 10kV

APLICACIONES / APPLICATIONS



Código Sku	Potencia Power (W)	Equivalencia Equivalence AM (W)	Flujo Luminoso Luminous Flux (lm)	Ángulo de Apertura Opening Angle	Temp. de Color Color Temp. (K)	IRC CRI	Vida Útil Life (h)	Dimensiones Dimensions (mm)	Color de Producto Product Color	Unidades por Caja Units per box
80326	75	1 x 175	9 375	115°	○ 4000	>80	50 000	Ø455 x 522	Blanco	1
80327	75	1 x 175	9 375	115°	● 5000	>80	50 000	Ø455 x 522	Blanco	1

* En sustitución de lámparas de aditivos metálicos / In the replacement of metal halide lamps.

ALUMBRADO PÚBLICO





LEDVANCE® SKY

Luminaria para alumbrado público elaborado con materiales de alta calidad, resistente a la lluvia y al polvo. Tiene un diseño compacto y moderno, acabado en gris. Disponible en temperatura de color: Blanco Frío (5000 K).

Outdoor lighting luminaire, made with high quality materials, resistant to rain and dust with modern and compact designs. Available in Cool Light (5000 K) temperature.



- HASTA 50% DE AHORRO DE ENERGÍA**
- 5 AÑOS DE GARANTÍA**
- 90 - 305 V~**
- IP66**
- IK08**
- 10kV**

incluye adaptador para fotocelda
photozell adapter included

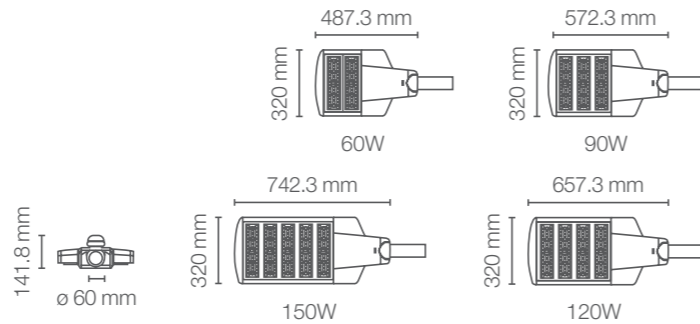

APLICACIONES / APPLICATIONS



Código Sku	Potencia Power (W)	Equivalencia Equivalence AM (W)	Flujo Luminoso Luminous Flux (lm)	Ángulo de Apertura Opening Angle	Temp. de Color Color Temp. (K)	IRC CRI	Vida Útil Life (h)	Dimensiones Dimensions (mm)	Color de Producto Product Color	Unidades por Caja Units per box
86516	60	100	6600	145°	5000	>80	50 000	487.3 x 320 x 141.8	Gris	1
86425	90	150	9900	145°	5000	>80	50 000	572.3 x 320 x 141.8	Gris	1
86426	120	200	13200	145°	5000	>80	50 000	657.3 x 320 x 141.8	Gris	1
86427	150	250	16500	145°	5000	>80	50 000	742.3 x 320 x 141.8	Gris	1

* En sustitución de lámparas de aditivos metálicos / In the replacement of metal halide lamps.

ÍNDICE LÁMPARAS DE LED OSRAM

CLASSIC

LED CLASSIC A19 SUPERSTAR®	70
LED CLASSIC A19 VALUE®	71
LED A19 ATENUABLE SUPERSTAR®	72
LED P45 SUPERSTAR®	73
LED VELAS SUPERSTAR®	74
LED VELAS SUPERSTAR® DIM	75
LED GLOBO SUPERSTAR®	76
LED A19 SENSOR SUPERSTAR®	77
LED CEILING LAMP	78
LED REPELLENT DUAL	79
LED EMERGENCY	80
LED CLASSIC P45 COLORS	81
LED SMART+ WIFI	83
LED A19 LEDVANCE SMART+	84
LED CONTROL REMOTO RGBW	85
LED VINTAGE 1906	87
LED FILAMENT CLASSIC	88
LED FILAMENT SPECIAL	89
LED HIGH WATTAGE SUPERSTAR®	90
LED HIGH WATTAGE ECO	91
LED HIGH WATTAGE E40 SUPERSTAR®	92
LED UFO E40 SUPERSTAR®	93
LED PIN BASE SUPERSTAR®	94



SPOT

LED AR111 SUPERSTAR®	96
LED SUPERIOR AR111 IRC90	97
LED MR16 SUPERSTAR®	98
LED PAR16 SUPERSTAR®	99
LED PAR16 SUPERSTAR IRC90	100
LED PAR16 RGBW	101
LED PAR16 VALUE	102
LED PAR20 SUPERSTAR®	103
LED PAR20 VALUE	104
LED PAR30 SUPERSTAR®	105
LED PAR30 SUPERSTAR® IP65	106
LED PAR30 HCI SUPERSTAR®	107
LED PAR30 VALUE	108
LED PAR38 SUPERSTAR® IP65	109
LED PAR38 VALUE	110



TUBOS LED

LED T8 SUPERIOR	113
LED T8 SUPERSTAR®	114
LED T8 SUPERSTAR® SENSOR	115
LED T8 VALUE G2	116
LED T8 ECO	117
LED T8 CURVALUM SUPERSTAR®	118
LED T8 SLIM SUPERSTAR®	119
LED T5 SUPERSTAR®	120



CLASSIC





LED CLASSIC A19 SUPERSTAR®

Familia de lámparas de LED ideales para iluminación general, disponibles en dos temperaturas de color: Luz Cálida (3000 K) y Luz Fría (6500 K).
Cuentan con una vida útil de 25 000 horas de vida y multivoltaje (100-240 V~).

LED CLASSIC A19 SUPERSTAR products are suitable for general lighting. Available in two different color temperatures, Warm Light (3000 K) and Cold Light (6500 K) possessing up to 25,000 hours life and high voltage range (100-240 V~).



- HASTA 85% DE AHORRO**
- 3 AÑOS DE GARANTÍA**
- HASTA 25 000h VIDA ÚTIL**
- 100 - 240 V~**

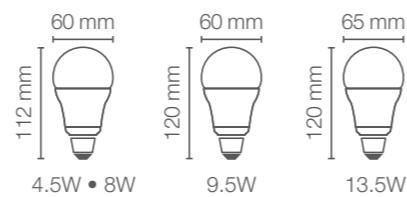

APLICACIONES / APPLICATIONS



Código Sku	Potencia Power (W)	Equivalencia Inc. (W)	Flujo Luminoso Luminous Flux (lm)	IRC CRI	Temp. Color Color Temp. (K)	Vida Útil Life (h)	Acabado Product Finishing	Base Base	Atenuable Dimmable	Dimensiones Dimensions (mm)	Unidades por Caja Units per box
85965	4.5	40	480	>80	3000	25 000	Opalino	E27	No	Ø 60 x 112	12
85966	4.5	40	480	>80	6500	25 000	Opalino	E27	No	Ø 60 x 112	12
85967	8	60	800	>80	3000	25 000	Opalino	E27	No	Ø 60 x 112	12
85968	8	60	800	>80	6500	25 000	Opalino	E27	No	Ø 60 x 112	12
85971	13.5	100	1521	>80	3000	25 000	Opalino	E27	No	Ø 65 x 120	12

* En sustitución de lámparas incandescentes / Replacing incandescent lamps.

LED CLASSIC A19 VALUE®

Familia de lámparas de LED ideales para iluminación general, disponibles en dos temperaturas de color: Luz Cálida (3000 K) y Luz Fría (6500 K).
Cuentan con una vida útil de 10 000 horas y voltaje dedicado (120V~).

LED CLASSIC A19 Value products are suitable for general lighting. Available in two different color temperatures, Warm Light (3000 K) and Cold Light (6500 K) possessing up to 10,000 hours life and 120V~ voltage range.



- HASTA 85% DE AHORRO**
- 3 AÑOS DE GARANTÍA**
- HASTA 10 000h VIDA ÚTIL**
- 120 V~**
-

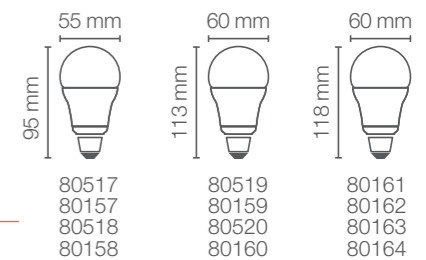

APLICACIONES / APPLICATIONS



Código Sku	Potencia Power (W)	Equivalencia Inc. (W)	Flujo Luminoso Luminous Flux (lm)	IRC CRI	Temp. Color Color Temp. (K)	Vida Útil Life (h)	Acabado Product Finishing	Base Base	Atenuable Dimmable	Dimensiones Dimensions (mm)	Unidades por Caja Units per box
MTO 80517	5	40 W	430	>80	2700	10 000	Opalino	E27	NO	57 x 57 x 99	12
80157	5	40 W	450	>80	3000	10 000	Opalino	E27	NO	58 x 57 x 99	12
MTO 80518	5	40 W	450	>80	4000	10 000	Opalino	E27	NO	59 x 57 x 99	12
80158	5	40 W	450	>80	6500	10 000	Opalino	E27	NO	60 x 57 x 99	12
MTO 80519	8.5	60 W	780	>80	2700	10 000	Opalino	E27	NO	62 x 62 x 117	12
80159	8.5	60 W	800	>80	3000	10 000	Opalino	E27	NO	63 x 62 x 117	12
MTO 80520	8.5	60 W	800	>80	4000	10 000	Opalino	E27	NO	64 x 62 x 117	12
80160	8.5	60 W	800	>80	6500	10 000	Opalino	E27	NO	65 x 62 x 117	12
80161	11	75 W	1000	>80	3000	10 000	Opalino	E27	NO	66 x 62 x 122	12
80162	11	75 W	1000	>80	6500	10 000	Opalino	E27	NO	67 x 62 x 122	12
80163	13	100 W	1500	>80	3000	10 000	Opalino	E27	NO	68 x 62 x 122	12
80164	13	100 W	1500	>80	6500	10 000	Opalino	E27	NO	69 x 62 x 122	12

* En sustitución de lámparas incandescentes / Replacing incandescent lamps.



LED A19 ATENUABLE SUPERSTAR®

La versión atenuable que permite el control de la intensidad de la luz, creando una atmósfera más acogedora en salas y dormitorios. Uso interior donde se requiera controlar la intensidad de iluminación mediante un dimmer.

The dimmable version is perfect to control the light intensity by a dimmer creating comfort in any room of your spaces. Available in Warm Light (3000 K).

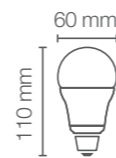

- HASTA 86% DE AHORRO**
- 3 AÑOS DE GARANTÍA**
- HASTA 25 000h VIDA ÚTIL**
- 127 V~**
- ATENUABLE**

APLICACIONES / APPLICATIONS



Código Sku	Potencia Power (W)	Equivalencia Inc. (W)	Flujo Luminoso Flux (lm)	IRC CRI	Temp. Color Color Temp. (K)	Vida Útil Life (h)	Acabado Product Finishing	Base Base	Atenuable Dimmable	Dimensiones Dimensions (mm)	Unidades por Caja Units per box
88131	8.5	60	806	>80	3000	25 000	Opalino	E27	Si	60 x 110	12

* En sustitución de lámparas incandescentes / Replacing incandescent lamps.

LED P45 SUPERSTAR®

La familia de lámparas P45 son ideales para aplicaciones residenciales que generan un confort de tranquilidad, ideales para lámparas de mesa y luminarias decorativas. Disponibles en 3W con base E12, E14 y E27.

LED P45 SUPERSTAR are perfect for residential application at living room's lamps, giving an unique relaxed comfort. Available in E12, E14 and E27 base.

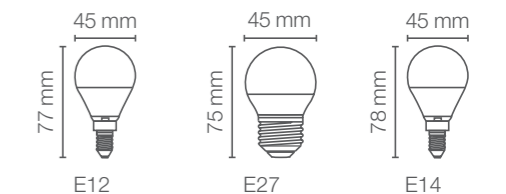

- HASTA 85% DE AHORRO**
- 3 AÑOS DE GARANTÍA**
- HASTA 15 000h VIDA ÚTIL**
- 100 - 240 V~**

APLICACIONES / APPLICATIONS

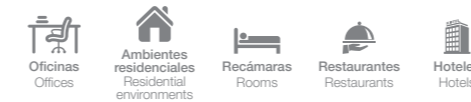

Código Sku	Potencia Power (W)	Equivalencia Inc. (W)	Flujo Luminoso Flux (lm)	IRC CRI	Temp. Color Color Temp. (K)	Vida Útil Life (h)	Acabado Product Finishing	Base Base	Atenuable Dimmable	Dimensiones Dimensions (mm)	Unidades por Caja Units per box
85962	3	25 W	260	>80	6500	15 000	Opalino	E12	N0	45 x 77	12
85975	3	25 W	260	>80	2700	15 000	Opalino	E27	N0	45 x 75	12
85976	3	25 W	260	>80	6500	15 000	Opalino	E27	N0	45 x 75	12
87891	3.5	25 W	260	>80	3000	16 000	Opalino	E14	N0	45 x 78	12

* En sustitución de lámparas incandescentes / Replacing incandescent lamps.



LED VELAS SUPERSTAR®

Las lámparas decorativas tipo vela ofrecen un ahorro de energía comparado con tecnologías tradicionales en versiones no atenuables con base E12 y E27.

The Candles Decorative Types offers energy savings compared with traditional technologies with NO DIM versions with E12 and E27 bases available.



3W E12 Opalino 3W E27 Opalino 3W E27 Clear

- HASTA 90% DE AHORRO**
- 3 AÑOS DE GARANTÍA**
- HASTA 15 000h VIDA ÚTIL**
- 100 - 240 V~**

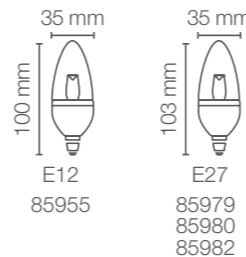

APLICACIONES / APPLICATIONS

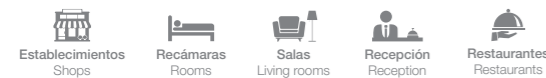

Código Sku	Potencia Power (W)	Equivalencia Inc. (W)	Flujo Luminoso Luminous Flux (lm)	IRC CRI	Temp. Color Color Temp. (K)	Vida Útil Life (h)	Acabado Product Finishing	Base Base	Atenuable Dimmable	Dimensiones Dimensions (mm)	Unidades por Caja Units per box
85955	3	25 W	260	>80	2700	15 000	Opalino	E12	NO	35 x 100	12
85979	3	25 W	260	>80	2700	15 000	Opalino	E27	NO	35 x 103	12
85980	3	25 W	260	>80	6500	15 000	Opalino	E27	NO	35 x 103	12
85982	3	25 W	260	>80	2700	15 000	Clear	E27	NO	35 x 103	12

* En sustitución de lámparas incandescentes / Replacing incandescent lamps.

LED VELAS SUPERSTAR® DIM

Las lámparas decorativas tipo vela ofrecen un ahorro de energía comparado con tecnologías tradicionales en versiones atenuables con base E14 y E27.

The Candles Decorative Types offers energy savings compared with traditional technologies with DIM versions with E14 and E27 bases available.



4W E14 4W E27

- HASTA 90% DE AHORRO**
- 3 AÑOS DE GARANTÍA**
- HASTA 15 000h VIDA ÚTIL**
- 127 V~**
- ATENUABLE**

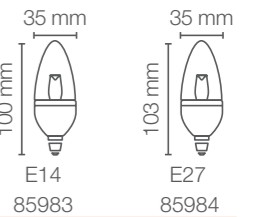

APLICACIONES / APPLICATIONS

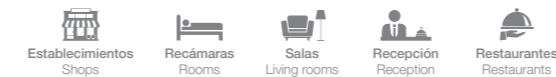

Código Sku	Potencia Power (W)	Equivalencia Inc. (W)	Flujo Luminoso Luminous Flux (lm)	IRC CRI	Temp. Color Color Temp. (K)	Vida Útil Life (h)	Acabado Product Finishing	Base Base	Atenuable Dimmable	Dimensiones Dimensions (mm)	Unidades por Caja Units per box
85983	4	25 W	350	>80	2700	15 000	Clear	E14	SI	35 x 100	12
85984	4	25 W	350	>80	2700	15 000	Clear	E27	SI	35 x 103	12

* En sustitución de lámparas incandescentes / Replacing incandescent lamps.



LED GLOBO SUPERSTAR®

Ideal para uso residencial y hotelería. Disponible en temperatura de color: Luz Cálida (2700 K) y Luz Fría (6500 K).

LED GLOBE SUPERSTAR are perfect for hospitality and residential applications. Available in Warm Light (2700 K) and Cold Light (6500 K).

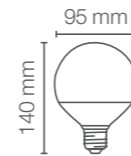

APLICACIONES / APPLICATIONS



Código Sku	Potencia Power (W)	Equivalencia Inc. (W)	Flujo Luminoso Luminous Flux (lm)	IRC CRI	Temp. Color Color Temp. (K)	Vida Útil Life (h)	Acabado Product Finishing	Base Base	Atenuable Dimmable	Dimensiones Dimensions (mm)	Unidades por Caja Units per box
86286	9	60	900	>80	2 700	15 000	Opalino	E27	NO	95 x 140	12
86287	9	60	900	>80	6 500	15 000	Opalino	E27	NO	95 x 140	12

* En sustitución de lámparas fluorescentes / Replacing fluorescent lamps.

LED A19 SENSOR SUPERSTAR®

LED A19 SENSOR SUPERSTAR es ideal para iluminar tus espacios sin necesidad de encender la luz cada vez que lo necesites, basta con dejar el interruptor encendido. La función de la lámpara es la detección de movimiento a un rango de 3 metros, es capaz de detectar si es de día o de noche para minimizar el consumo eléctrico de la lámpara. Incluye sensor infrarrojo integrado.

LED A19 SENSOR SUPERSTAR is perfect to light up your spaces without using the switch everytime you need it, just one switch on and the motion sensor will be working to light on/off if it detects some movements from a special range of distance. Available in Warm Light (3000 K) and Day Light (6500 K).

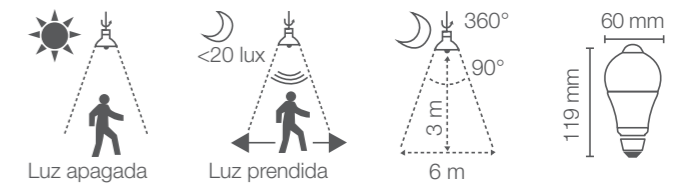

APLICACIONES / APPLICATIONS

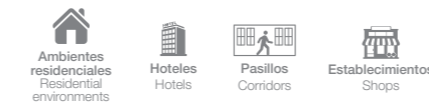

Código Sku	Potencia Power (W)	Equivalencia Inc. (W)	Flujo Luminoso Luminous Flux (lm)	IRC CRI	Temp. Color Color Temp. (K)	Vida Útil Life (h)	Acabado Product Finishing	Base Base	Atenuable Dimmable	Dimensiones Dimensions (mm)	Unidades por Caja Units per box
88152	9	60	806	>80	3 000	25 000	Opalino	E27	NO	60 x 119	12
88153	9	60	806	>80	6 500	25 000	Opalino	E27	NO	60 x 119	12

* En sustitución de lámparas incandescentes / Replacing incandescent lamps.



LED CEILING LAMP®

La familia de productos LED CEILING LAMP es ideal para aplicaciones residenciales con un diseño original y estético con un tamaño perfecto para cualquier hogar. Disponible en temperatura: Luz Cálida (3000 K), Luz Neutra (4000 K) y Luz Fría (6500 K) con base E27.

LED CEILING LAMP products are perfect to use in residential applications with an unique and esthetic design and a perfect size to place anywhere. Available in Warm Light (3000 K), Neutral Light (4000 K) and Cold Light (6500 K) with E27 base.

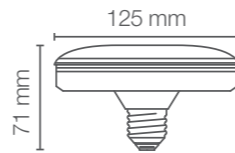

APLICACIONES / APPLICATIONS



Código Sku	Potencia Power (W)	Equivalencia Inc. (W)	Flujo Luminoso Luminous Flux (lm)	IRC CRI	Temp. Color Color Temp. (K)	Vida Útil Life (h)	Acabado Product Finishing	Base Base	Atenuable Dimmable	Dimensiones Dimensions (mm)	Unidades por Caja Units per box
88173	14.5	100	1 300	>80	3 000	15 000	Opalino	E27	N0	125 x 71	12
88175	14.5	100	1 400	>80	4 000	15 000	Opalino	E27	N0	125 x 71	12
88176	14.5	100	1 400	>80	6 500	15 000	Opalino	E27	N0	125 x 71	12

* En sustitución de lámparas incandescentes / Replacing incandescent lamps.

LED REPELLENT DUAL®

Una misma lámpara, dos beneficios. Iluminación general Luz Fría (6500 K) y amarillo (Repelente). Cambia de función con cada encendido y apagado. Ideal para zonas húmedas y mucha vegetación.

One lamp, two functions: General lighting at Cold Light (6500 K) and repellent mode. Changes the function just with one switch, best option for humidity zones.

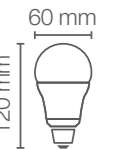

APLICACIONES / APPLICATIONS



Uso exterior solo con luminarios.

Código Sku	Potencia Power (W)	Equivalencia Inc. (W)	Flujo Luminoso Luminous Flux (lm)	IRC CRI	Temp. Color Color Temp. (K)	Vida Útil Life (h)	Acabado Product Finishing	Base Base	Atenuable Dimmable	Dimensiones Dimensions (mm)	Unidades por Caja Units per box
88067	8	60	806	>80	6500 + Luz amarilla (Repelente)	25 000	Opalino	E27	N0	60 x 120	12

* En sustitución de lámparas incandescentes / Replacing incandescent lamps.



LED EMERGENCY

La lámpara de emergencia asegura la iluminación en todo momento, ya que funciona como un bulbo normal y gracias a su batería integrada, cambia a modo emergencia de forma automática cuando haya una interrupción en la energía eléctrica (hasta 2.5 hrs)

The lamp has two working modes, it works as a common light bulb and it switches to emergency mode after power shut down automatically (2.5 hrs)

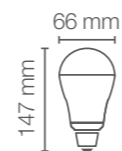

- HASTA 87% DE AHORRO**
- 2 AÑOS DE GARANTÍA**
- HASTA 15 000h VIDA ÚTIL**
- 100 - 240 V ~**
- Batería de litio integrada**

APLICACIONES / APPLICATIONS

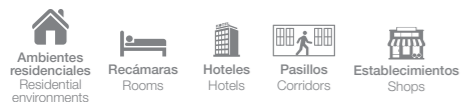

Código Sku	Potencia Power (W)	Equivalencia Inc. (W)	Flujo Luminoso Luminous Flux (lm)	IRC CRI	Temp. Color Color Temp. (K)	Vida Útil Life (h)	Acabado Product Finishing	Base Base	Atenuable Dimmable	Dimensiones Dimensions (mm)	Unidades por Caja Units per box
80107	10	60	806	>80	3 000	15 000	Opalino	E27	NO	66 x 147	12
80108	10	60	850	>80	6 500	15 000	Opalino	E27	NO	66 x 147	12

LED CLASSIC P45 COLORS

La familia de lámparas CLASSIC P45 COLORS son ideales para aplicaciones decorativas en cuatro colores distintos que generan un ambiente único.

The CLASSIC P45 COLORS family are ideal for decorative applications in four different colors that create a unique atmosphere.

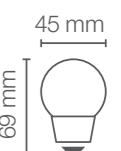

- HASTA 85% DE AHORRO**
- 3 AÑOS DE GARANTÍA**
- HASTA 15 000h VIDA ÚTIL**
- 100 - 240 V ~**

APLICACIONES / APPLICATIONS

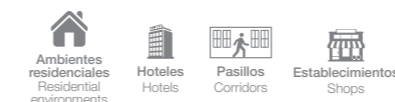

Código Sku	Potencia Power (W)	Equivalencia Inc. (W)	IRC CRI	Temp. Color Color Temp. (K)	Vida Útil Life (h)	Base Base	Atenuable Dimmable	Dimensiones Dimensions (mm)	Unidades por Caja Units per box
80226	1.2	25	>80	Verde	15 000	E27	NO	Ø 45 x 69	12
80227	1.2	25	>80	Amarillo	15 000	E27	NO	Ø 45 x 69	12
80228	1.2	25	>80	Rojo	15 000	E27	NO	Ø 45 x 69	12
80229	1.2	25	>80	Azul	15 000	E27	NO	Ø 45 x 69	12

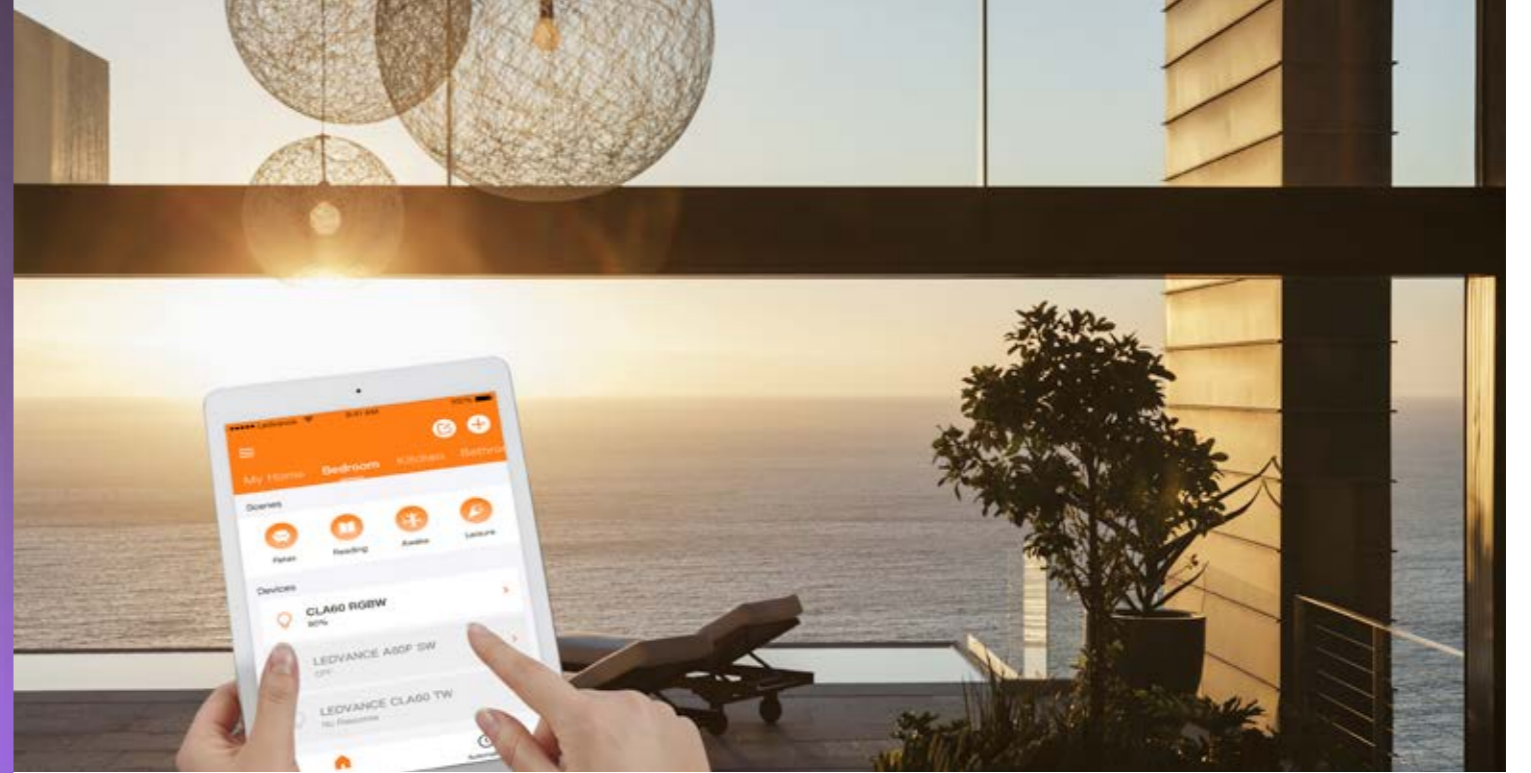

LED SMART+ WIFI®

Conexión vía WiFi (Disponible para Android y iOS). Cuenta con dos tipos de iluminación: Blanco Dinámico (2700 K a 6500 K) o Iluminación decorativa (RGB). Controla el color, intensidad, escenas e incluso el ritmo de la luz desde la aplicación Ledvance Smart+ WiFi en tu celular, o a través de comandos de voz (Alexa y Google Home).

Connected by WiFi (Available for Android and iOS). It has two types of lighting: Dynamic White (2700 K to 6500 K) or Decorative Lighting (RGB). Control the color, intensity, scenes and even the rhythm of the light from the Ledvance Smart + WiFi application on your cell phone, or through voice commands (Alexa and Google Home).



80954



80955

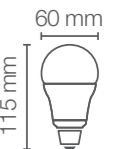

APLICACIONES / APPLICATIONS



Código Sku	Potencia Power (W)	Equivalencia Inc. (W)	Flujo Luminoso Flux (lm)	IRC CRI	Temp. Color Color Temp. (K)	Vida Útil Life (h)	Acabado Product Finishing	Base Base	Atenuable Dimmable	Dimensiones Dimensions (mm)	Unidades por Caja Units per box
80954	9	60	800	>80	RGBW	15 000	Opalino	E27	Si	60 x 115	4
80955	9	60	800	>80	2 700	15 000	Opalino	E27	Si	60 x 115	4

* En sustitución de lámparas incandescentes / Replacing incandescent lamps.



LED A19 LEDVANCE SMART+®

Conexión vía Bluetooth Mesh Network (Disponible para Android y iOS). Cuenta con dos tipos de iluminación: Iluminación general (2700 K a 6500 K) o Iluminación decorativa (RGB). Puede ser usada mediante comandos de voz (Siri y Google). Control de la intensidad de color mediante aplicación.

Connected and controlled by Bluetooth, available for Android and iOS. It can be switched to different colors (RGBW), change the color temperature (2700 K to 6500 K) and it can be dimmable from 0% to 100% creating scenes for each ambient you want to control. Also it can be managed by voice commands from Google and Siri.

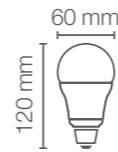

APLICACIONES / APPLICATIONS

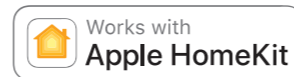

Código Sku	Potencia Power (W)	Equivalencia Inc. (W)	Flujo Luminoso Luminous Flux (lm)	IRC CRI	Temp. Color Color Temp. (K)	Vida Útil Life (h)	Acabado Product Finishing	Base Base	Atenuable Dimmable	Dimensiones Dimensions (mm)	Unidades por Caja Units per box
88112	10	60	800	>80	RGBW	15 000	Opalino	E27	Si	60 x 120	4

LED CONTROL REMOTO RGBW®

La familia LED RGBW es un sistema de iluminación controlado vía control remoto que cuenta con control de intensidad y cambio de colores, personaliza tus ambientes con un estilo único con control de atenuación.

LED RGBW REMOTE CONTROL products are a special illumination system controlled by infrared remote control with dimmable controls and change of some colors to personalize your spaces with an unique style with dimming control.



7.5W

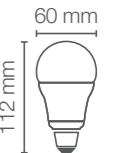

APLICACIONES / APPLICATIONS



Código Sku	Potencia Power (W)	Equivalencia Inc. (W)	Flujo Luminoso Luminous Flux (lm)	IRC CRI	Temp. Color Color Temp. (K)	Vida Útil Life (h)	Acabado Product Finishing	Base Base	Atenuable Dimmable	Dimensiones Dimensions (mm)	Unidades por Caja Units per box
86277	7.5	60	600	>80	RGBW	15 000	Opalino	E27	SI	112 x 60 x 60	12 caja
86281	7.5	60	600	>80	RGBW	15 000	Opalino	E27	SI	112 x 60 x 60	6 blister

* En sustitución de lámparas incandescentes / Replacing incandescent lamps.

* En sustitución de lámparas incandescentes / Replacing incandescent lamps.

** Atenuable únicamente mediante control remoto (incluido) / Dimmable only by remote control (included).



LED VINTAGE® 1906

Lámparas de estilo vintage para decorar tus espacios con estilos inigualables y con un ahorro de energía de hasta 90% comparado con tecnologías tradicionales, disponibles con base E12 y E27 con acabado ambar en temperatura Luz Cálida (2500 K).

LED VINTAGE 1906 are perfect to decorate your lighting spaces with incomparable styles, saving energy up to 90% vs. traditional technologies. Available in E12 and E27 base with ambar finish in Warm Light (2500 K).



LED FIL
CLA B 3.5



LED FIL
CLA B 4.5



85940

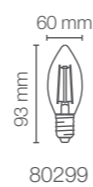

80299



APLICACIONES / APPLICATIONS



Código Sku	Potencia Power (W)	Equivalencia Inc. (W)	Flujo Luminoso Luminous Flux (lm)	IRC CRI	Temp. Color Color Temp. (K)	Vida Útil Life (h)	Acabado Product Finishing	Base Base	Atenuable Dimmable	Dimensiones Dimensions (mm)	Unidades por Caja Units per box
85940	3.5	25 W	300	>80	2 500	15 000	Ambar	E12	SI	35 x 97	12
80299	4.5	40 W	420	>80	2 500	20 000	Ambar	E27	SI	60 x 93	12

* En sustitución de lámparas incandescentes / Replacing incandescent lamps.

LED VINTAGE® 1906

Lámparas de estilo vintage para decorar tus espacios con estilos inigualables y con un ahorro de energía de hasta 90% comparado con tecnologías tradicionales, disponibles con base E27 y E26 con acabado ambar en temperatura Luz Cálida (2500 K).

LED VINTAGE 1906 are perfect to decorate your lighting spaces with incomparable styles, saving energy up to 90% vs. traditional technologies. Available in E27 and E26 base with ambar finish in Warm Light (2500 K).



LED FIL CLA60

LED VINTAGE
1906 A19

LED VINTAGE
1906 GLOBE

LED VINTAGE
1906 ST64



80296

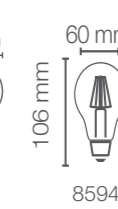

85941

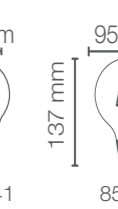

85942

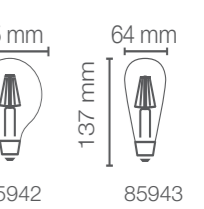

85943



APLICACIONES / APPLICATIONS

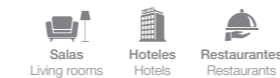

Código Sku	Potencia Power (W)	Equivalencia Inc. (W)	Flujo Luminoso Luminous Flux (lm)	IRC CRI	Temp. Color Color Temp. (K)	Vida Útil Life (h)	Acabado Product Finishing	Base Base	Dimensiones Dimensions (mm)	Unidades por Caja Units per box
80296	7	60 W	725	>80	2 500	20 000	Ambar	E27	60 x 104	12
85941	4.5	40 W	360	>80	2 500	15 000	Ambar	E26	60 x 106	12
85942	4.5	40 W	360	>80	2 500	15 000	Ambar	E26	95 x 137	6
85943	4.5	40 W	360	>80	2 500	15 000	Ambar	E26	64 x 137	6

* En sustitución de lámparas incandescentes / Replacing incandescent lamps.



LED FILAMENT CLASSIC

La familia de lámparas LED FILAMENT son ideales para aplicaciones decorativas, donde se quiera dar un toque único en los espacios, creando ambientes de confort y tranquilidad.

The family of LED FILAMENT lamps are ideal for decorative applications, where you want to give a unique touch in the spaces, creating environments of comfort and tranquility



- HASTA 90% DE AHORRO**
- 3 AÑOS DE GARANTÍA**
- HASTA 25 000h VIDA ÚTIL**
- 100-240 V~**
- LED FILAMENTO**
- EDITION 1906**

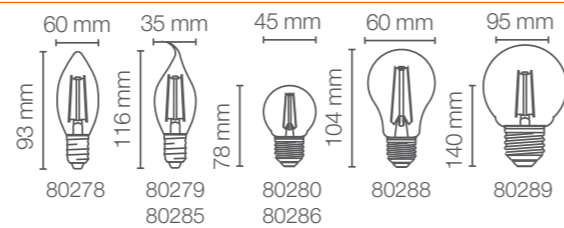

APLICACIONES / APPLICATIONS



Código Sku	Potencia Power (W)	Equivalencia Inc. (W)	Flujo Luminoso Luminous Flux (lm)	IRC CRI	Temp. Color Color Temp. (K)	Vida Útil Life (h)	Acabado Product Finishing	Tipo de bulbo Bulb	Base Base	Dimensiones Dimensions (mm)	Unidades por Caja Units per box
80278	2.5	25 W	250	>80	2 700	15 000	Clear	B10	E27	60 x 93	12
80279	2.5	25 W	250	>80	2 700	15 000	Clear	CA10	E27	35 x 116	12
80285	2.5	25 W	250	>80	2 700	15 000	Opalino	CA10	E27	35 x 116	12
80280	2.5	25 W	250	>80	2 700	15 000	Clear	P45	E27	45 x 78	12
80286	2.5	25 W	250	>80	2 700	15 000	Opalino	P45	E27	45 x 78	12
80288	7	60 W	806	>80	2 700	25 000	Opalino	A19	E27	60 x 104	12
80289	4.5	40 W	470	>80	2 700	15 000	Opalino	G95	E27	95 x 140	6

* En sustitución de lámparas incandescentes / Replacing incandescent lamps.

LED FILAMENT SPECIAL

La familia de lámparas LED FILAMENT es ideal para aplicaciones decorativas, donde se quiera dar un toque especial, gracias a sus diseños únicos, creando ambientes de confort y tranquilidad

The family of LED FILAMENT lamps are ideal for decorative applications, where you want to give a special touch thanks to their unique designs, creating environments of comfort and tranquility



- HASTA 90% DE AHORRO**
- 2 AÑOS DE GARANTÍA**
- HASTA 15 000h VIDA ÚTIL**
- 100-240 V~**
- LED FILAMENTO**
- EDITION 1906**

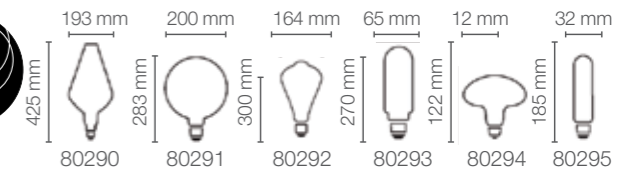

APLICACIONES / APPLICATIONS



Código Sku	Potencia Power (W)	Equivalencia Inc. (W)	Flujo Luminoso Luminous Flux (lm)	IRC CRI	Temp. Color Color Temp. (K)	Vida Útil Life (h)	Acabado Product Finishing	Tipo de bulbo Bulb	Base Base	Dimensiones Dimensions (mm)	Unidades por Caja Units per box
80290	5	25 W	90	>80	1 800	15 000	Negro	NO DEFINIDO	E27	193 x 425	2
80291	5	25 W	250	>80	4 000	15 000	Negro	G200	E27	200 x 283	2
80292	5	25 W	350	>80	2 000	15 000	Ambar	ST164	E27	164 x 300	2
80293	5	25 W	350	>80	2 000	15 000	Ambar	T65	E27	65 x 270	4
80294	2	25 W	225	>80	2 500	15 000	Ambar	M120	E27	12 x 122	5
80295	5	25 W	250	>80	2 000	15 000	Ambar	T32	E27	32 x 185	12

* En sustitución de lámparas incandescentes / Replacing incandescent lamps.



LED HIGH WATTAGE SUPERSTAR®

La familia de LED Alta Potencia con base E27 son una excelente solución para la sustitución de lámparas fluorescentes ahorradoras compactas, ideales para aplicaciones residenciales y comerciales.

LED HIGH WATTAGE SUPERSTAR products are suitable for residential and commercial applications, replacing high wattage compact fluorescent lamps up to 80W. Direct replacement with E27 base.

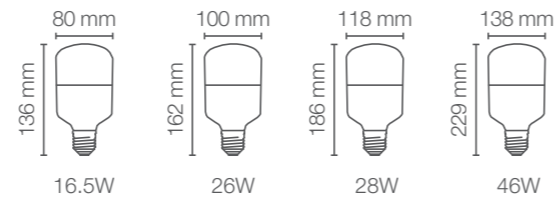

APLICACIONES / APPLICATIONS



Código Sku	Potencia Power (W)	Equivalencia Equivalence CFLi. (W)	Flujo Luminoso Luminous Flux (lm)	IRC CRI	Temp. Color Color Temp. (K)	Vida Útil Life (h)	Acabado Product Finishing	Base Base	Atenuable Dimmable	Dimensiones Dimensions (mm)	Unidades por Caja Units per box
80904	16.5 W	30	1 800	>80	6 500	25 000	Opalino	E27	NO	Ø 80 X 136	12
85825	26 W	45	2 800	>80	6 500	25 000	Opalino	E27	NO	Ø 100 X 162	12
80906	28 W	65	3 700	>80	6 500	25 000	Opalino	E27	NO	Ø 118 X 186	6
85827	46 W	80	4 850	>80	6 500	25 000	Opalino	E27	NO	Ø 138 X 229	6

* En sustitución de lámparas incandescentes / Replacing incandescent lamps.

LED HIGH WATTAGE ECO

La familia de LED High Wattage Eco con base E27 es una excelente sustitución de lámparas fluorescentes ahorradoras compactas, ofreciendo una solución funcional a tu alcance.

The ECO HIGH POWER LED family with E27 base is an excellent replacement for compact energy saving fluorescent lamps, offering a functional solution at your fingertips.

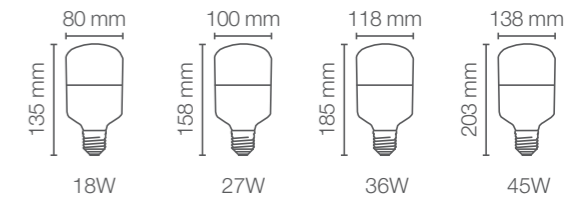

APLICACIONES / APPLICATIONS



Código Sku	Potencia Power (W)	Equivalencia Equivalence CFLi. (W)	Flujo Luminoso Luminous Flux (lm)	IRC CRI	Temp. Color Color Temp. (K)	Vida Útil Life (h)	Acabado Product Finishing	Base Base	Atenuable Dimmable	Dimensiones Dimensions (mm)	Unidades por Caja Units per box
80579	18	30	1 800	>80	6 500	10 000	Opalino	E27	NO	80 x 135	8
80580	27	45	2 800	>80	6 500	10 000	Opalino	E27	NO	100 x 158	8
80581	36	65	3 800	>80	6 500	10 000	Opalino	E27	NO	118 x 185	8
80582	45	80	4 850	>80	6 500	10 000	Opalino	E27	NO	138 x 203	8

* En sustitución de lámparas incandescentes / Replacing incandescent lamps.



LED HIGH WATTAGE E40 SUPERSTAR®

La familia de lámparas de altas potencias con base E40 es ideal para bodegas, almacenes, establecimientos o aplicaciones industriales para sustituir lámparas de aditivos metálicos y ahorrar hasta 50% en el consumo eléctrico. Disponibles en base mogül (E40) y voltaje 100-277 V~. Solo para interiores.

LED HIGH WATTAGE E40 SUPERSTAR are perfect for indoor industrial applications replacing traditional technologies like mercury or sodium lamps saving energy up to 50% and high voltage range (100-277 V~).



APLICACIONES / APPLICATIONS



Código Sku	Potencia Power (W)	Equivalencia Equivalence CFLI. (W)	Flujo Luminoso Luminous Flux (lm)	IRC CRI	Temp. Color Color Temp. (K)	Vida Útil Life (h)	Acabado Product Finishing	Base Base	Atenuable Dimmable	Dimensiones Dimensions (mm)	Unidades por Caja Units per box
86293	65	100	5 800	>80	6 500	25 000	Opalino	E40	NO	145 x 217	4
86294	80	125	7 800	>80	6 500	25 000	Opalino	E40	NO	170 x 229	4
86295	100	175	9 500	>80	6 500	25 000	Opalino	E40	NO	190 x 270	2
86296	120	250	12 000	>80	6 500	25 000	Opalino	E40	NO	190 x 270	2

* En sustitución de lámparas incandescentes / Replacing incandescent lamps.

LED UFO E40 SUPERSTAR®

Alto flujo luminoso, sustitución de lámparas tradicionales como lámparas de mercurio hasta 250 W. Altura de montaje recomendable hasta 8 metros. Bajo consumo de energía. Base Mogül (E40).

High luminous flux, perfect replacement for traditional technologies up to 250W. Ideal mounting height is up to 8 meters with energy saving up to 70% and high CRI >80.



80W • 92W

150W

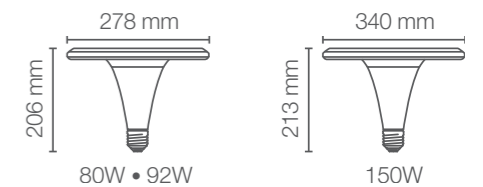

80W • 92W

150W



APLICACIONES / APPLICATIONS



Código Sku	Potencia Power (W)	Equivalencia Equivalence Inc. (W)	Flujo Luminoso Luminous Flux (lm)	IRC CRI	Temp. Color Color Temp. (K)	Vida Útil Life (h)	Base Base	Atenuable Dimmable	Dimensiones Dimensions (mm)	Unidades por Caja Units per box
88149	80	175	8 500	>80	6 500	25 000	E40	NO	278 x 206	2
88150	92	250	12 000	>80	6 500	25 000	E40	NO	278 x 206	2
88151	150	400	18 000	>80	6 500	25 000	E40	NO	340 x 213	2

* En sustitución de lámparas de aditivo metálico. / Replacing metal halide lamps.



SPOT

LED PIN BASE SUPERSTAR®

Las lámparas LED PIN BASE SUPERSTAR son ideales para aplicaciones comerciales, brindando un ahorro de energía de hasta 50% con una vida útil de 30 000 horas de vida garantizando años de servicio y reducción de costos de mantenimiento. Es el perfecto sustituto de lámparas fluorescentes pin base con base G24Q, 2G11, G23 y 2G7. Driver integrado con rango de voltaje de 120-277 V~.

LED PIN BASE SUPERSTAR are perfect for commercial applications, offering an energy saving up to 50% with 30 000 hours life guarantying years of service and maintenance saving costs. Perfect replacement for fluorescent pin base lamps with G24Q, 2G11, G23 and 2G7 base.

No external ballast or driver needed. Voltage range of 120-277 V~.

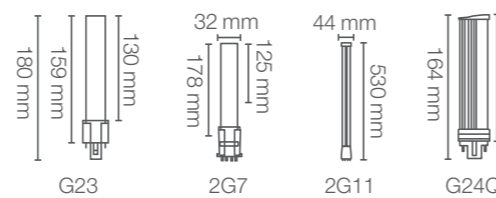

- HASTA 50% DE AHORRO**
- 3 AÑOS DE GARANTÍA**
- HASTA 30 000h VIDA ÚTIL**
- 120 - 277 V~**
- 2700K 4000K**

APLICACIONES / APPLICATIONS



Código Sku	Potencia Power (W)	Equivalencia Inc. (W)	Flujo Luminoso Luminous Flux (lm)	IRC CRI	Temp. Color Color Temp. (K)	Vida Útil Life (h)	Acabado Product Finishing	Base Base	Atenuable Dimmable	Dimensiones Dimensions (mm)	Unidades por Caja Units per box
85191	6	13 (Dulux S)	490	>80	● 2 700	30 000	Opalino	G23	No	159	20
85192	6	13 (Dulux S)	540	>80	○ 4 000	30 000	Opalino	G23	No	159	20
85195	6	13 (Dulux SE)	540	>80	○ 4 000	30 000	Opalino	2G7	No	32 x 171	20
80115	17	40 (Dulux L)	2200	>80	○ 4 000	30 000	Opalino	2G11	No	44 x 530	30
80118	8	26 (Dulux DE)	800	>80	○ 4 000	30 000	Opalino	G24Q	No	149	50

* En sustitución de lámparas fluorescentes / Replacing fluorescent lamps.



LED AR111 SUPERSTAR®

Las lámparas de LED AR111 SUPERSTAR combinan con un diseño tradicional de halógeno con tecnología innovadora. Cuentan con driver integrado con un rango de voltaje de 100-240 V~. Disponibles en base G53 y GU10 con 24° y 40°, además con opción no atenuable y atenuable.

*Ideales para luminarias LEDVANCE Tracklight y LEDVANCE Multispot.



LED AR111 SUPERSTAR products have a traditional halogen design with new LED technology. Does not need any external ballast or driver to operate. Voltage range of 100-240 V~. Available at G53 and GU10 base with 24° and 40°, additionally with dimmable and not dimmable version.

*Ideal for LEDVANCE Tracklight and LEDVANCE Multispot Luminaires.

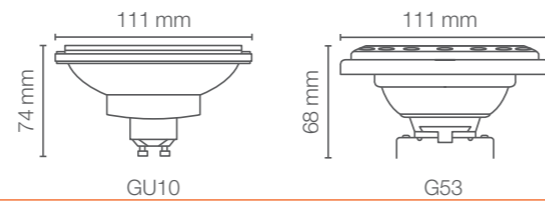

APLICACIONES / APPLICATIONS



Código Sku	Potencia Power (W)	Equivalencia Equivalencia Halógena (W)	Flujo Luminoso Luminous Flux (lm)	Ángulo de Apertura Opening Angle	IRC CRI	Temp. Color Color Temp. (K)	Vida Útil Life (h)	Base Base	Atenuable Dimmable	Dimensiones Dimensions (mm)	Unidades por Caja Units per box
86354	12	75	950	24°	>80	2 700	25 000	GU10	No	111 x 74	12
86355	12	75	950	24°	>80	2 700	25 000	GU10	Si	111 x 74	12
86356	12	75	950	40°	>80	2 700	25 000	GU10	Si	111 x 74	12
86357	12	75	950	40°	>80	2 700	25 000	G53	Si	111 x 68	12

* En sustitución de lámparas halógenas / Replacing halogen lamps.

LED SUPERIOR AR111 IRC90

Las lámparas AR111 aseguran una iluminación profesional, debido a su alto IRC (90), ideal para boutiques, showrooms, galerías, museos, etc. donde se requiera una alta fidelidad de color.

*Ideales para luminarias LEDVANCE Tracklight y LEDVANCE Multispot.



The AR111 lamps ensure professional lighting, due to its high IRC (90), ideal for boutiques, showrooms, galleries, museums, etc. where high color fidelity is required.

*Ideal for LEDVANCE Tracklight and LEDVANCE Multispot Luminaires.

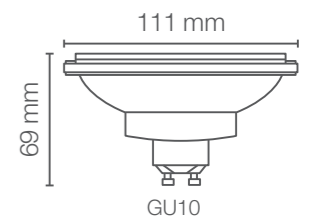

APLICACIONES / APPLICATIONS



Código Sku	Potencia Power (W)	Equivalencia Equivalencia Halógena (W)	Flujo Luminoso Luminous Flux (lm)	Ángulo de Apertura Opening Angle	IRC CRI	Temp. Color Color Temp. (K)	Vida Útil Life (h)	Base Base	Atenuable Dimmable	Dimensiones Dimensions (mm)	Unidades por Caja Units per box
80176	10	75	750	12°	>90	2 700	25 000	GU10	No	111 x 69	12
80177	10	75	750	24°	>90	2 700	25 000	GU10	No	111 x 69	12

* En sustitución de lámparas halógenas / Replacing halogen lamps.



LED MR16 VALUE®

La familia LED MR16 Value es ideal para iluminación de acento en aplicaciones residenciales y comerciales, disponible en temperatura: Luz Cálida (2700 K), (3000 K), Luz Neutra (4000 K) y Luz Fría (6500 K). Reemplazan a la tecnología de halógeno de 50 W. ¡Incluye porta lámpara para evitar accidentes!.

LED MR16 VALUE products are perfect for accent lighting at residential and hospitality applications. Available in Temperatures (2700 K), (3000 K), (4000 K) and (6500 K). Includes lamp holder to avoid accidents!.

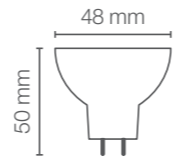

APLICACIONES / APPLICATIONS



Código Sku	Potencia Power (W)	Equivalencia Equivalence Halógena (W)	Flujo Luminoso Luminous Flux (lm)	Ángulo de Apertura Opening Angle	IRC CRI	Temp. Color Color Temp. (K)	Vida Útil Life (h)	Base Base	Atenuable Dimmable	Dimensiones Dimensions (mm)	Unidades por Caja Units per box
85987	5	50	400	36°	>80	● 2 700	15 000	GU5.3	No	48 x 50	12
85886	5	50	400	36°	>80	● 3 000	15 000	GU5.3	No	48 x 50	12
85988	5	50	400	36°	>80	○ 4 000	15 000	GU5.3	No	48 x 50	12
85897	5	50	450	36°	>80	● 6 500	15 000	GU5.3	No	48 x 50	12

* En sustitución de lámparas halógenas / Replacing halogen lamps.

LED PAR16 SUPERSTAR®

Las lámparas PAR16 SUPERSTAR son ideales para destacar objetos (cuadros, esculturas, rasgos arquitectónicos, etc) y lugares (baños de luz en las paredes y la luz de teatro).

LED PAR16 SUPERSTAR lamps are ideal for highlighting objects (paintings, sculptures, architectural features, etc) and places (light baths on the walls and theater light). Available in dimmable version.

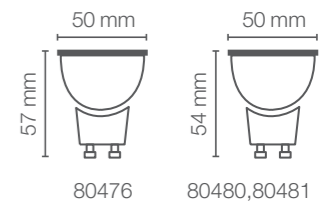

APLICACIONES / APPLICATIONS



Código Sku	Potencia Power (W)	Equivalencia Equivalence Halógena (W)	Voltaje Voltage (V)	Flujo Luminoso Luminous Flux (lm)	Ángulo de Apertura Opening Angle	IRC CRI	Temp. Color Color Temp. (K)	Vida Útil Life (h)	Base Base	Atenuable Dimmable	Dimensiones Dimensions (mm)	Unidades por Caja Units per box
80476	5.5	60	127	550	35°	>80	● 2 700	25 000	GU10	Si	50 x 57	12
80480	6	60	100-240	525	35°	>80	● 2 700	25 000	GU10	No	54 x 50	12
80481	6	60	100-240	550	35°	>80	● 6 500	25 000	GU10	No	54 x 50	12

* En sustitución de lámparas halógenas / Replacing halogen lamps.



LED PAR16 SUPERSTAR® IRC90

La lámparas PAR16 aseguran una iluminación profesional, debido a su alto IRC >90, ideal para boutiques, showrooms, galerías, museos, etc. donde se requiera una alta fidelidad de color.

The AR111 lamps ensure professional lighting, due to its high IRC (90%), ideal for boutiques, showrooms, galleries, museums, etc. where high color fidelity is required



- HASTA
90%
DE
AHORRO
- 3**
AÑOS DE
GARANTÍA
- HASTA
25 000h
VIDA ÚTIL
- 100 – 240 V~

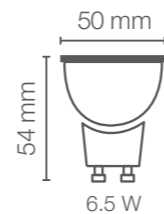

APLICACIONES / APPLICATIONS

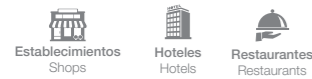

Código Sku	Potencia Power (W)	Equivalencia Equivalence Halógena (W)	Flujo Luminoso Luminous Flux (lm)	Ángulo de Apertura Opening Angle	IRC CRI	Temp. Color Color Temp. (K)	Vida Útil Life (h)	Base Base	Atenuable Dimmable	Dimensiones Dimensions (mm)	Unidades por Caja Units per box
80478	6.5	60	525	35°	>90	2 700	25 000	GU10	No	50 x 54	12
80479	6.5	60	550	35°	>90	6 500	25 000	GU10	No	50 x 54	12

* En sustitución de lámparas halógenas / Replacing halogen lamps.

LED PAR16 RGBW®

La familia LED RGBW es un sistema de iluminación comandado vía control remoto que cuenta con atenuación de intensidad y cambio de colores, personaliza tus ambientes con un estilo único.

LED RGBW REMOTE CONTROL products are a special illumination system controlled by infrared remote control with dimmable controls and change of some colors to personalize your spaces with an unique style with dimming control.



4.5W

- 2**
AÑOS DE
GARANTÍA
- HASTA
15 000h
VIDA ÚTIL
- 100-240 V~
- ATENUABLE
- COLOR
RGBW

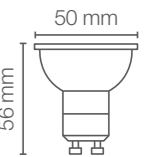

APLICACIONES / APPLICATIONS



Código Sku	Potencia Power (W)	Flujo Luminoso Luminous Flux (lm)	Ángulo de Apertura Opening Angle	IRC CRI	Temp. Color Color Temp. (K)	Vida Útil Life (h)	Base Base	Atenuable Dimmable	Dimensiones Dimensions (mm)	Unidades por Caja Units per box
88066	4.5	250	36°	>80	2 700 + RGBW	15 000	GU10	Si**	50 x 56	12

* En sustitución de lámparas incandescentes / Replacing incandescent lamps.

** Atenuable únicamente mediante control remoto (incluido) / Dimmable only by remote control (included).



LED PAR16 VALUE

Las lámparas PAR16 VALUE garantizan una correcta iluminación de acento en objetos o elementos arquitectónicos. Disponibles en Luz Cálida (2 700 K) y Luz Fría (6 500 K).

PAR16 VALUE lamps ensure correct accent lighting on architectural objects or elements. Available in Warm Light (2 700 K) and Cold Light (6 500 K).



PAR16

- HASTA 90% DE AHORRO**
- 3 AÑOS DE GARANTÍA**
- HASTA 25 000h VIDA ÚTIL**
- 100-240 V~**

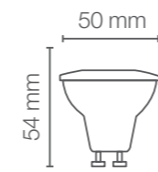

80474 y 80475

APLICACIONES / APPLICATIONS



Código Sku	Potencia Power (W)	Equivalencia Equivalence Halógena (W)	Flujo Luminoso Luminous Flux (lm)	Ángulo de Apertura Opening Angle	IRC CRI	Temp. Color Color Temp. (K)	Vida Útil Life (h)	Base Base	Atenuable Dimmable	Dimensiones Dimensions (mm)	Unidades por Caja Units per box
80474	4	50	350	35°	>80	● 2 700	25 000	GU10	No	50 x 54	12
80475	4	50	370	35°	>80	● 6 500	25 000	GU10	No	50 x 54	12

* En sustitución de lámparas halógenas / Replacing halogen lamps.



LED PAR20 SUPERSTAR®

Las lámparas PAR20 SUPERSTAR en su versión atenuable, son ideales para denotar objetos y lugares en temperatura Luz Cálida (2 700 K) y Luz Fría (6 500 K).

PAR20 SUPERSTAR lamps in their dimmable version, are ideal for denoting objects and places in warm light temperature (2 700 K) and Cold Light (6 500 K).



PAR20

- HASTA 90% DE AHORRO**
- 3 AÑOS DE GARANTÍA**
- HASTA 25 000h VIDA ÚTIL**
- 127 V~**
- ATENUABLE***



80484

APLICACIONES / APPLICATIONS



Código Sku	Potencia Power (W)	Equivalencia Equivalence Halógena (W)	Voltaje Voltage (V~)	Flujo Luminoso Luminous Flux (lm)	Ángulo de Apertura Opening Angle	IRC CRI	Temp. Color Color Temp. (K)	Vida Útil Life (h)	Base Base	Atenuable Dimmable	Dimensiones Dimensions (mm)	Unidades por Caja Units per box
80484	6	50	127	525	25°	>80	● 2 700	25 000	E27	Si	63 x 85	12

* En sustitución de lámparas halógenas / Replacing halogen lamps.



LED PAR20 VALUE

Las lámparas PAR20 VALUE garantizan una correcta iluminación de acento en objetos o elementos arquitectónicos. Disponibles en Luz Cálida (2 700 K) y Luz Fría (6 500 K).

PAR20 VALUE lamps ensure correct accent lighting on architectural objects or elements. Available in Warm Light (2 700 K) and Cold Light (6 500 K).



PAR20

- HASTA 90% DE AHORRO**
- 3 AÑOS DE GARANTÍA**
- HASTA 25 000h VIDA ÚTIL**
- 100-240 V~**

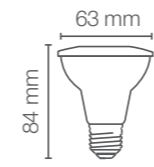

80482 y 80483

APLICACIONES / APPLICATIONS



Código Sku	Potencia Power (W)	Equivalencia Equivalence Halógena (W)	Flujo Luminoso Luminous Flux (lm)	Ángulo de Apertura Opening Angle	IRC CRI	Temp. Color Color Temp. (K)	Vida Útil Life (h)	Base Base	Atenuable Dimmable	Dimensiones Dimensions (mm)	Unidades por Caja Units per box
80482	5.5	50	525	40°	>80	● 2 700	25 000	E27	No	63 x 84	12
80483	5.5	50	550	40°	>80	● 6 500	25 000	E27	No	63 x 84	12

* En sustitución de lámparas halógenas / Replacing halogen lamps.

LED PAR30 SUPERSTAR®

Las lámparas PAR30 SUPERSTAR atenuables son ideales para iluminación de acento en base E27, reemplaza a la tecnología de halógeno de 75 W.

The dimmable PAR30 SUPERSTAR lamps are ideal for accent lighting on E27 base, replace the 75 W halogen technology.



83026



83150 y 80486

- HASTA 80% DE AHORRO**
- 3 AÑOS DE GARANTÍA**
- HASTA 25 000h VIDA ÚTIL**
- ATENUABLE***
- 120-277 V~**
- 127 V~**

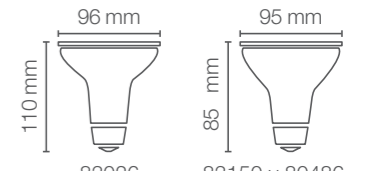

83026 83150 y 80486

APLICACIONES / APPLICATIONS



Código Sku	Potencia Power (W)	Equivalencia Equivalence Halógena (W)	Voltaje Voltage (V~)	Flujo Luminoso Luminous Flux (lm)	Ángulo de Apertura Opening Angle	IRC CRI	Temp. Color Color Temp. (K)	Vida Útil Life (h)	Base Base	Atenuable Dimmable	Dimensiones Dimensions (mm)	Unidades por Caja Units per box
83026	12	26	120	900	40°	>80	● 3000	25 000	E27	No	96 x 110	6
83150	9	75	120	800	40°	>80	● 3000	25 000	E27	Si	95 x 85	10
80486	9.5	75	127	900	25°	>80	● 2 700	25 000	E27	Si	95 x 85	12

* En sustitución de lámparas halógenas / Replacing halogen lamps.



LED PAR30 SUPERSTAR® IP65

Las lámparas PAR30 SUPERSTAR son ideales para iluminación de acento en exteriores, ya que cuentan con IP65, disponibles en Temperatura de color Cálida (2 700 K y 3 000 K) y Luz Fría (6 500 K).

PAR30 SUPERSTAR lamps are ideal for outdoor accent lighting as it has IP65, available in Warm color temperature (2 700 K and 3 000 K) and Cold Light (6 500 K).



80490 / 80491 80492 / 80493

- HASTA 80% DE AHORRO**
- 3 AÑOS DE GARANTÍA**
- HASTA 25 000h VIDA ÚTIL**
- IP 65**
- 100-277 V~**

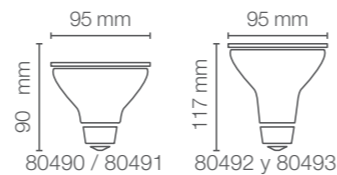

APLICACIONES / APPLICATIONS



Código Sku	Potencia Power (W)	Equivalencia Equivalence Halógena (W)	Flujo Luminoso Luminous Flux (lm)	Ángulo de Apertura Opening Angle	IRC CRI	Temp. Color Color Temp. (K)	Vida Útil Life (h)	Base Base	Atenuable Dimmable	Dimensiones Dimensions (mm)	Unidades por Caja Units per box
80490	9.5	75	900	25°	>80	2 700	25 000	E27	No	95 x 90	12
80491	9.5	75	1000	25°	>80	6 500	25 000	E27	No	95 x 90	12
80492	9.5	75	900	25°	>80	2 700	25 000	E27	No	95 x 117	12
80493	9.5	75	1000	25°	>80	6 500	25 000	E27	No	95 x 117	12

* En sustitución de lámparas halógenas / Replacing halogen lamps.

LED PAR30 HCI SUPERSTAR®

Las lámparas LED PAR30 HCI SUPERSTAR son ideales para aplicaciones comerciales y profesionales, ya que cuentan con alto flujo luminoso de hasta 3100 lúmenes con opciones de IRC 80 e IRC 90 con base E27. Disponible en 15° y 30° en temperaturas de color desde 3000 K hasta 6500 K, sustituyendo lámparas de aditivos metálicos cerámicos HCI PAR30 de 70 W.

LED PAR30 HCI SUPERSTAR are perfect for commercial and professional applications due high luminous flux up to 3100lm with two options of CRI of 80 and 90 with E27 base. Available in 15° and 30° and color temperatures from 3000 K up to 6500 K, the perfect replacement for 70 W PAR30 HCI Halogen Lamps.



IRC 90 IRC 80

- HASTA 61% DE AHORRO**
- 3 AÑOS DE GARANTÍA**
- HASTA 15 000h VIDA ÚTIL**
- 100 - 277 V~**
- 3000K 4000K 6500K**
- ALTO FLUJO LUMINOSO**
- LED COB**

APLICACIONES / APPLICATIONS

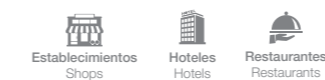

Código Sku	Potencia Power (W)	Equivalencia Equivalence Halógena (W)	Flujo Luminoso Luminous Flux (lm)	Ángulo de Apertura Opening Angle	IRC CRI	Temp. Color Color Temp. (K)	Vida Útil Life (h)	Base Base	Atenuable Dimmable	Dimensiones Dimensions (mm)	Unidades por Caja Units per box
88136	29	75	3000	30	>80	3 000	15000	E27	NO	95 x 125	12
88137	29	75	3000	30	>80	4 000	15000	E27	NO	95 x 125	12
88138	29	75	3000	30	>80	6 500	15000	E27	NO	95 x 125	12
87958	37	75	3100	15	>90	3 000	15000	E27	NO	95 x 125	12
87959	37	75	3100	15	>90	4 000	15000	E27	NO	95 x 125	12
87960	37	75	3100	30	>90	3 000	15000	E27	NO	95 x 125	12
87961	37	75	3100	30	>90	4 000	15000	E27	NO	95 x 125	12

* En sustitución de lámparas halógenas / Replacing halogen lamps.



LED PAR30 VALUE

La familia LED Superstar PAR30 es ideal para usos comerciales ya que su acentuación direccional ofrece calidad de luz inigualable. Disponibles en temperatura: Luz Cálida (2 700 K) y Luz Fría (6 500 K).

LED PAR30 SUPERSTAR products are perfect for indoor and outdoor applications with an unique accent offering a magnificent quality. Available in Warm Light (2700 K) and Cold Light (6500 K).



PAR30

- HASTA 85% DE AHORRO
- 3 AÑOS DE GARANTÍA
- HASTA 25 000h VIDA ÚTIL
- 100 - 240 V~

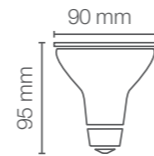

APLICACIONES / APPLICATIONS



Código Sku	Potencia Power (W)	Equivalencia Equivalence Halógena (W)	Flujo Luminoso Luminous Flux (lm)	Ángulo de Apertura Opening Angle	IRC CRI	Temp. Color Color Temp. (K)	Vida Útil Life (h)	Base	Dimensiones Dimensions (mm)	Unidades por Caja Units per box
80488	9.5	75	900	25°	>80	2 700	25 000	E27	90 x 95	12
80489	9.5	75	940	25°	>80	6 500	25 000	E27	90 x 95	12

* En sustitución de lámparas halógenas / Replacing halogen lamps.



LED PAR38 SUPERSTAR® IP65

Las lámparas PAR38 SUPERSTAR son ideales para iluminación de acento en exteriores, ya que cuentan con IP65, disponibles en Temperatura de color Cálida (2 700 K y 3 000 K) y Luz Fría (6 500 K).

PAR38 SUPERSTAR lamps are ideal for outdoor accent lighting as it has IP65, available in Warm color temperature (2 700 K and 3 000 K) and Cold Light (6 500 K).



80496 / 80497

- HASTA 80% DE AHORRO
- 3 AÑOS DE GARANTÍA
- HASTA 25 000h VIDA ÚTIL
- IP65
- 100-277 V~

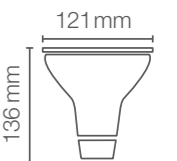

80496 y 80497

APLICACIONES / APPLICATIONS



Código Sku	Potencia Power (W)	Equivalencia Equivalence Halógena (W)	Flujo Luminoso Luminous Flux (lm)	Ángulo de Apertura Opening Angle	IRC CRI	Temp. Color Color Temp. (K)	Vida Útil Life (h)	Base	Atenuable Dimmable	Dimensiones Dimensions (mm)	Unidades por Caja Units per box
80496	13.5	90	1400	30°	>80	2 700	25 000	E27	No	121 x 136	12
80497	13.5	90	1600	30°	>80	6 500	25 000	E27	No	121 x 136	12

* En sustitución de lámparas halógenas / Replacing halogen lamps.



LED PAR38 VALUE

La familia LED Superstar PAR38 es ideal para usos comerciales ya que su acentuación direccional ofrece calidad de luz inigualable. Disponibles en temperatura: Luz Cálida (2 700 K) y Luz Fría (6 500 K).

LED PAR38 SUPERSTAR products are perfect for indoor and outdoor applications with an unique accent offering a magnificent quality. Available in Warm Light (2700 K) and Cold Light (6500 K).



PAR38

- HASTA**
85%
DE
AHORRO
- 3**
AÑOS DE
GARANTÍA
- HASTA**
25 000h
VIDA ÚTIL
- 100 - 240 V~**

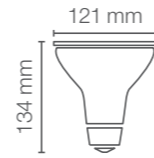

APLICACIONES / APPLICATIONS



Código Sku	Potencia Power (W)	Equivalencia Equivalence Halógena (W)	Flujo Luminoso Luminous Flux (lm)	Ángulo de Apertura Opening Angle	IRC CRI	Temp. Color Color Temp. (K)	Vida Útil Life (h)	Base Base	Dimensiones Dimensions (mm)	Unidades por Caja Units per box
80494	13.5	90	1400	30°	>80	● 2 700	25 000	E27	121 x 134	12
80495	13.5	90	1500	30°	>80	● 6 500	25 000	E27	121 x 134	12

* En sustitución de lámparas halógenas / Replacing halogen lamps.

TUBOS LED



LED T8 SUPERIOR

Las lámparas LED T8 SUPERIOR son ideales para aplicaciones comerciales y corporativas debido a su alto rango de voltaje (120-277 V~) y hasta 50,000 horas de vida. No necesita driver o balastro externo. Disponibles en 120cm y en todas las temperaturas de color. Material de vidrio.

LED T8 SUPERIOR products are perfect for comercial, industrial and corporate application due to wide voltage range (120-277 V~) and high hours life up to 50,000 hours. Does not need external ballast or driver. Available in 120 cm and all color temperatures. Glass material.



-  HASTA 50% DE AHORRO
-  5 AÑOS DE GARANTÍA
-  HASTA 50 000h VIDA ÚTIL
-  120 - 277 V~
-  G13



APLICACIONES / APPLICATIONS



	Código Sku	Potencia Power (W)	Equivalencia Equivalence Fluor. (W)	Flujo Luminoso Luminous Flux (lm)	IRC CRI	Temp. Color Color Temp. (K)	Vida Útil Life (h)	Acabado Product Finishing	Base Base	Dimensiones Dimensions (mm)	Unidades por Caja Units per box
MTO	80109	17	32 W	2200	>82	5000	50 000	Opalino	G13	1212 x 26	25
MTO	80110	17	32 W	2200	>82	3000	50 000	Opalino	G13	1212 x 26	25
MTO	80111	17	32 W	2200	>82	4000	50 000	Opalino	G13	1212 x 26	25
MTO	80112	17	32 W	2200	>82	6500	50 000	Opalino	G13	1212 x 26	25

* En sustitución de lámparas fluorescentes tubulares. / Replacing tubular fluorescent lamps.



LED T8 SUPERSTAR®

Las lámparas LED T8 SUPERSTAR son ideales para aplicaciones comerciales y corporativas debido a su alto rango de voltaje (100-277 V~) y hasta 40,000 horas de vida. No necesita driver o balastro externo. Disponibles en 60cm y 120cm. Material de vidrio.

LED T8 SUPERSTAR products are perfect for industrial application due to wide voltage range (100-277 V~) and high hours life up to 40,000 hours. Does not need external ballast or driver. Available in 2ft and 4ft. Glass material.



- HASTA 50% DE AHORRO**
- 3 AÑOS DE GARANTÍA**
- HASTA 40 000h VIDA ÚTIL**
- 100 - 277 V~**
- 3000K / 4000K**

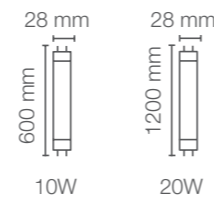

APLICACIONES / APPLICATIONS



Código Sku	Potencia Power (W)	Equivalencia Fluor. (W)	Flujo Luminoso Luminous Flux (lm)	IRC CRI	Temp. Color Color Temp. (K)	Vida Útil Life (h)	Acabado Product Finishing	Base Base	Dimensiones Dimensions (mm)	Unidades por Caja Units per box
80202	10	17	1000	>80	● 4 000	40 000	Opalino	G13	28 x 600	25
80205	20	32	1800	>80	○ 3 000	40 000	Opalino	G13	28 x 1200	25
80206	20	32	2000	>80	● 4 000	40 000	Opalino	G13	28 x 1200	25

* En sustitución de lámparas fluorescentes tubulares. / Replacing tubular fluorescent lamps.

LED T8 SUPERSTAR® SENSOR

Las lámparas LED T8 SUPERSTAR SENSOR son ideales para aplicaciones comerciales y corporativas debido a su alto rango de voltaje (100-277 V~), cuenta con un sensor microondas de 5m y hasta 25,000 horas de vida. No necesita driver o balastro externo. Disponibles en 60cm y 120cm y en todas las temperaturas de color. Material de vidrio.

LED T8 SUPERSTAR SENSOR products are perfect for industrial application due to wide voltage range (100-277 V~), it has a 5m microwave sensor and high hours life up to 25,000 hours. Does not need external ballast or driver. Available in 2ft and 4ft and all color temperatures. Glass material.



- HASTA 50% DE AHORRO**
- 3 AÑOS DE GARANTÍA**
- HASTA 25 000h VIDA ÚTIL**
- 100 - 277 V~**
- 4000K / 6500K**



APLICACIONES / APPLICATIONS

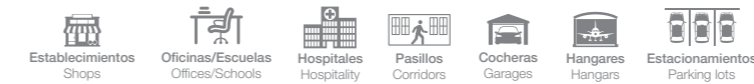

Código Sku	Potencia Power (W)	Equivalencia Fluor. (W)	Flujo Luminoso Luminous Flux (lm)	IRC CRI	Temp. Color Color Temp. (K)	Vida Útil Life (h)	Acabado Product Finishing	Base Base	Dimensiones Dimensions (mm)	Unidades por Caja Units per box
80238	18	32	2000	>80	○ 4000	25 000	Opalino	G13	1200 x 28	25
80239	18	32	2000	>80	● 6500	25 500	Opalino	G13	1200 x 28	25

* En sustitución de lámparas fluorescentes tubulares. / Replacing tubular fluorescent lamps.



TUBO LED T8 VALUE® G3

Los tubos de LED T8 VALUE son una solución versátil para todo tipo de aplicaciones con bajo consumo de energía. No necesitan balastro.

LED T8 VALUE ideal for versatile lighting solutions, saving energy up to 50%. Does not need external ballast or driver.

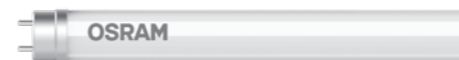

8W • 16W



16W Claro

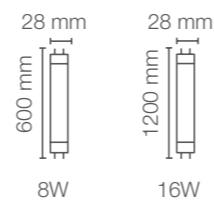

APLICACIONES / APPLICATIONS



Código Sku	Potencia Power (W)	Equivalencia Fluor. (W)	Flujo Luminoso Luminous Flux (lm)	IRC CRI	Temp. Color Color Temp. (K)	Vida Útil Life (h)	Acabado Product Finishing	Base Base	Atenuable Dimmable	Dimensiones Dimensions (mm)	Unidades por Caja Units per box
88408	16	32	1 600	>80	3000	15 000	Opalino	G13	NO	1200 x 28	25
88409	16	32	1 600	>80	4000	15 000	Opalino	G13	NO	1200 x 28	25
88410	16	32	1 600	>80	5000	15 000	Opalino	G13	NO	1200 x 28	25
88411	16	32	1 600	>80	6500	15 000	Opalino	G13	NO	600 x 28	25
88412	8	17	800	>81	3000	15 000	Opalino	G13	NO	600 x 28	25
88413	8	17	800	>82	4000	15 000	Opalino	G13	NO	600 x 28	25
88414	8	17	800	>83	5000	15 000	Opalino	G13	NO	600 x 28	25
88415	8	17	800	>84	6500	15 000	Opalino	G13	NO	600 x 28	25
88416	16	32	1 600	>80	4000	15 000	Clear	G13	NO	1200 x 28	25
88417	16	32	1 600	>80	6500	15 000	Clear	G13	NO	1200 x 28	25

* En sustitución de lámparas fluorescentes tubulares. / Replacing tubular fluorescent lamps.



TUBO LED T8 ECO®

Los tubos de LED T8 ECO son una solución para aquellas aplicaciones con iluminación práctica y funcional ya que no necesitan balastro.

LED T8 ECO ideal for functional lighting solutions. Does not need external ballast or driver.

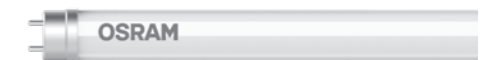

8W • 16W



16W Claro

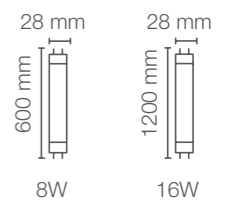

APLICACIONES / APPLICATIONS



Código Sku	Potencia Power (W)	Equivalencia Fluor. (W)	Flujo Luminoso Luminous Flux (lm)	IRC CRI	Temp. Color Color Temp. (K)	Vida Útil Life (h)	Acabado Product Finishing	Base Base	Dimensiones Dimensions (mm)	Unidades por Caja Units per box
80186	8	17	800	>80	4000	15 000	Opalino	G13	600 x 28	25
80189	16	32	1440	>80	3000	15 000	Opalino	G13	1200 x 28	25
80192	16	32	1600	>80	6500	15 500	Opalino	G13	1200 x 28	25

* En sustitución de lámparas fluorescentes tubulares. / Replacing tubular fluorescent lamps.



LED T8 CURVALUM SUPERSTAR®

Las lámparas LED T8 CURVALUM SUPERSTAR ofrecen el reemplazo ideal de tubos fluorescentes de 32W, cuentan con driver integrado ahorrando energía de hasta 50%. Driver integrado. Disponible en temperatura Luz Neutra (4000 K) y Luz Fría (6500 K).

LED T8 CURVALUM SUPERSTAR are the ideal fluorescent tubes substitution, offering integrated driver and saving energy up to 50%. Available in Neutral light (4000 K) and Cold Light (6500 K) temperature.

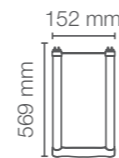

- HASTA 50% DE AHORRO**
- 3 AÑOS DE GARANTÍA**
- HASTA 50 000h VIDA ÚTIL**
- 120 - 277 V~**

APLICACIONES / APPLICATIONS



Código Sku	Potencia Power (W)	Equivalencia Equivalence Fluor. (W)	Flujo Luminoso Luminous Flux (lm)	IRC CRI	Temp. Color Color Temp. (K)	Vida Útil Life (h)	Acabado Product Finishing	Base Base	Dimensiones Dimensions (mm)	Unidades por Caja Units per box
86341	18	32	2200	>80	○ 4000	50 000	Opalino	G13	596 x 152	12
86342	18	32	2200	>80	● 6500	50 000	Opalino	G13	596 x 152	12

* En sustitución de lámparas fluorescentes tubulares. / Replacing tubular fluorescent lamps.

LED T8 SLIM SUPERSTAR®

La lámpara LED T8 SLIM SUPERSTAR ofrece alto flujo luminoso, reemplazando T8 fluorescente Slimline de 59W. Driver integrado. Disponible en temperatura de Luz Fría (6500 K).

LED T8 SLIM SUPERSTAR offers high luminous flux, replacing T8 59W Slimline. Does not need external driver or ballast. Available at Cold Light temperature (6500 K).



- HASTA 50% DE AHORRO**
- 3 AÑOS DE GARANTÍA**
- HASTA 30 000h VIDA ÚTIL**
- 100 - 277 V~**
- G13**

APLICACIONES / APPLICATIONS



Código Sku	Potencia Power (W)	Equivalencia Equivalence Fluor. (W)	Flujo Luminoso Luminous Flux (lm)	IRC CRI	Temp. Color Color Temp. (K)	Vida Útil Life (h)	Acabado Product Finishing	Base Base	Dimensiones Dimensions (mm)	Unidades por Caja Units per box
87900	36	60	3600	>80	● 6500	30 000	Opalino	G13	2373 x 28	8

* En sustitución de lámparas fluorescentes tubulares. / Replacing tubular fluorescent lamps.



LED T5 SUPERSTAR®

Las lámparas LED T5 SUPERSTAR cuentan con 5 años de garantía y 50,000 horas de vida, el sustituto ideal de tubos fluorescentes T5 de 14W, 28W y 54W ahorrando energía de hasta 50%. Cuentan con driver integrado. Hasta una eficacia de 150 lm/W.

LED T5 SUPERSTAR products offer 5 warranty years and 50,000 hours life and integrated driver. The ideal substitution of 14W, 28W and 54W T5 Fluorescent tubes, saving energy up to 50%. Efficacy up to 150 lm/W.

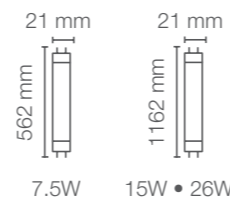
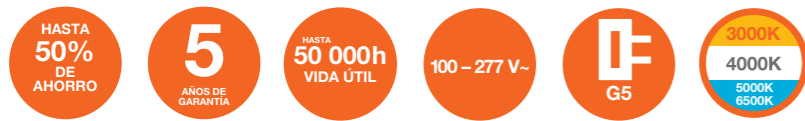
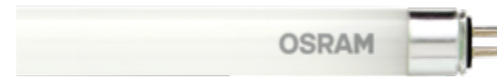

APLICACIONES / APPLICATIONS



Código Sku	Potencia Power (W)	Equivalencia Fluor. (W)	Flujo Luminoso Luminous Flux (lm)	IRC CRI	Temp. Color Color Temp. (K)	Vida Útil Life (h)	Acabado Product Finishing	Base Base	Dimensiones Dimensions (mm)	Unidades por Caja Units per box
87892	7.5	17	900	>80	3000	50 000	Opalino	G5	562 x 21	25
85828	7.5	17	900	>80	4000	50 000	Opalino	G5	562 x 21	25
85829	7.5	17	900	>80	6500	50 500	Opalino	G5	562 x 21	25
85830	15	28	1850	>80	3000	50 000	Opalino	G5	1162 x 21	25
85831	15	28	1850	>80	4000	50 000	Opalino	G5	1162 x 21	25
85832	15	28	1850	>80	5000	50 000	Opalino	G5	1162 x 21	25
85833	15	28	1850	>80	6500	50 500	Opalino	G5	1162 x 21	25
85834	26	54	3600	>80	3000	50 000	Opalino	G5	1162 x 21	25
85835	26	54	3900	>80	4000	50 000	Opalino	G5	1162 x 21	25
85836	26	54	3900	>80	5000	50 000	Opalino	G5	1162 x 21	25
85837	26	54	3900	>80	6500	50 500	Opalino	G5	1162 x 21	25

* En sustitución de lámparas fluorescentes tubulares. / Replacing tubular fluorescent lamps.



ÍNDICE

COMPONENTES ELECTRÓNICOS

LEDVANCE

TIRAS LED

ECOFLEX	123
TIRAS LED ECOFLEX 12V	123
DRIVERS	124
ACCESORIOS	124
ECOKIT	125
TIRA LED ECOFLEX 127V	126
ACCESORIOS	127
PRIMEFLEX	128
TIRA LED PRIMEFLEX 24V	128
DRIVERS	129
ACCESORIOS	129



SENSORES DE MOVIMIENTO

USO INTERIOR	130
USO EXTERIOR	130
USO EXTERIOR INDUSTRIAL	131



FOTOCELDA

FOTOCELDA	132
-----------	-----



SISTEMAS DE EMERGENCIA

SISTEMAS DE EMERGENCIA	133
------------------------	-----



SISTEMAS DE CONTROL INALÁMBRICO smARTlight[®]

GATEWAY BLE	135
DRIVER BLE	135
CONTROL DE PARED BLE	136
SENSOR BLE	136
RELEVADORES BLE	137
INTERFAZ BLE	137
DIMMER BLE	138
CONTROLADOR DE TIRAS LED RGBW BLE	138



TIRAS LED ECOFLEX 12V

Descubre la versatilidad que nuestras tiras ofrecen, ideal para iluminación de áreas interiores y exteriores, para crear ambientes únicos y resaltar detalles finos para darle un toque arquitectónico a los espacios, garantizando la misma tonalidad de luz a lo largo de su vida útil.

Discover the versatility that our strips offer, ideal for lighting indoor and outdoor areas, to create unique environments and highlight fine details to give an architectural touch to spaces, guaranteeing the same light tone throughout its useful life.

2

AÑOS DE GARANTÍA

12V

DC

5m

LONGITUD



APLICACIONES / APPLICATIONS



Código Sku	Potencia/ m Power/m (W)	Flujo Luminoso Luminous Flux (lm/m)	Temp. Color Color Temp. (K)	Protección Protection	Vida Útil Life (h)	Uso Use	Dimensiones Dimensions (mm)	Unidades por Caja Units per box
86230	4.8	380	● 2700	IP20	20 000	Interior	5000 x 8 x 1.4	10
86231	4.8	400	○ 4000	IP20	20 000	Interior	5000 x 8 x 1.4	10
86232	4.8	400	● 6500	IP20	20 000	Interior	5000 x 8 x 1.4	10
86233	12	900	● 2700	IP20	20 000	Interior	5000 x 10 x 1.4	10
86235	12	950	○ 4000	IP20	20 000	Interior	5000 x 10 x 1.4	10
86236	12	950	● 6500	IP20	20 000	Interior	5000 x 10 x 1.4	10
86237	4.8	360	● 2700	IP65	20 000	Exterior	5025 x 10.3 x 4	10
86238	4.8	380	○ 4000	IP65	20 000	Exterior	5025 x 10.3 x 4	10
86239	4.8	380	● 6500	IP65	20 000	Exterior	5025 x 10.3 x 4	10
86240	12	850	● 2700	IP65	20 000	Exterior	5025 x 12.8 x 4.4	10
86242	12	900	● 6500	IP65	20 000	Exterior	5025 x 12.8 x 4.4	10

* No incluye driver. / Does not include driver.

DRIVERS ECOFLEX 12V

Complementa tu diseño de Iluminación con tiras adicionando drivers de aplicación interior o exterior que energicen adecuadamente tus tiras ECOFLEX 12V.

Complement your lighting design with strips adding drivers for interior or exterior application that adequately energize your ECOFLEX 12V strips.

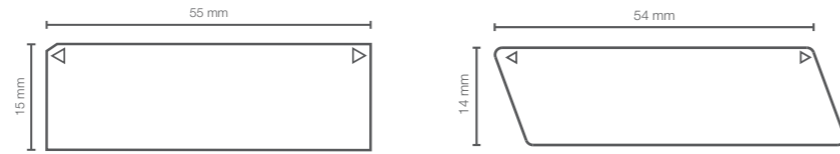

Código Sku	Potencia Power (W)	Parámetros de salida Output parameters		Protección Protection	Uso Use	Ideal para tiras Ideal for strips	Dimensiones Dimensions (mm)	Unidades por Caja Units per box
		Tensión (V)	Corriente (A)					
86316	30	12	2.5	IP20	Interior	ECOFLEX IP20	150 x 43 x 30	25
86317	60	12	5	IP20	Interior	ECOFLEX IP20	182 x 43 x 38	18
86318	30	12	2.5	IP67	Exterior	ECOFLEX IP65	146 x 40 x 29	15
86319	60	12	5	IP67	Exterior	ECOFLEX IP65	160 x 42 x 31	15

ACCESORIOS ECOFLEX 12V

Aumenta las posibilidades de instalación y diversifica tus diseños integrando conectores de fácil conexión: I, L, T y X.

Increase the installation possibilities and diversify your designs by integrating easy connection connectors: I, L, T and X.

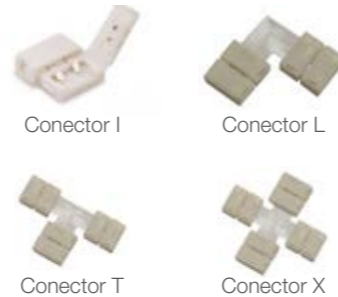

Código Sku	Descripción Description	Uso Use	Ideal para tiras Ideal for strips	Unidades por Caja Units per box
88855	Conector I 8mm	Interior	ECOFLEX 4.8W IP20	20
88857	Conector L 8mm	Interior	ECOFLEX 4.8W IP20	20
88859	Conector T 8mm	Interior	ECOFLEX 4.8W IP20	20
88861	Conector X 8mm	Interior	ECOFLEX 4.8W IP20	20
88863	Plug de silicón 8mm	Exterior	ECOFLEX 4.8W IP65	20
83878	Conector de entrada macho 8mm	Exterior	ECOFLEX 4.8W IP65	20
88869	Tornillo para cintad LED	Exterior	ECOFLEX 4.8W & 12W IP65	20
83877	Gel adhesivo de silicón	Exterior	ECOFLEX 4.8W & 12W IP65	20
88856	Conector I 10mm	Interior	ECOFLEX 12W IP20	20
88858	Conector L 10mm	Interior	ECOFLEX 12W IP20	20
88860	Conector T 10mm	Interior	ECOFLEX 12W IP20	20
88862	Conector X 10mm	Interior	ECOFLEX 12W IP20	20
88864	Plug de silicón 10mm	Exterior	ECOFLEX 12W IP65	20
88865	Conector de entrada hembra 10mm	Exterior	ECOFLEX 12W IP65	20
88866	Conector de entrada macho M13	Exterior	ECOFLEX 4.8W IP65 & 12W IP65	20
88867	Conector de entrada hembra M11	Exterior	ECOFLEX 4.8W IP65 & 12W IP65	20



ECOKIT

Kit de Tira LED + Driver de fácil instalación para crear diferentes escenarios y atmósferas confortables en interiores.

Easy to install LED Strip + Driver Kit to create different scenarios and comfortable atmospheres indoors.



APLICACIONES / APPLICATIONS

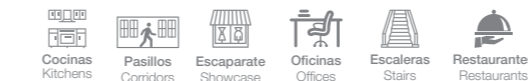

Código Sku	Potencia/ m Power/m (W)	Flujo Luminoso Luminous Flux (lm/m)	Temp. Color Color Temp. (K)	Protección Protection	Vida Útil Life (h)	Uso Use	Dimensiones Dimensions (mm)	Unidades por Caja Units per box
86243	4.8	380	● 2700	IP20	20 000	Interior	5000 x 8 x 1.4	10
86244	4.8	400	○ 4000	IP20	20 000	Interior	5000 x 8 x 1.4	10
86245	4.8	400	● 6500	IP20	20 000	Interior	5000 x 8 x 1.4	10



TIRAS LED ECOFLEX 127V

Integra tiras de LED a tus diseños exteriores y rediseña tus espacios, con la posibilidad de integrar sistemas de atenuación sin la necesidad de drivers adicionales.

Integrate LED strips into your exterior designs and redesign your spaces, with the possibility of integrating dimming systems without the need for additional drivers.



IP44

IP65

APLICACIONES / APPLICATIONS



Código Sku	Potencia/ m Power/m (W)	Flujo Luminoso Luminous Flux (lm/m)	Temp. Color Color Temp. (K)	Protección Protection	Vida Útil Life (h)	Uso Use	Longitud Length	Dimensiones Dimensions (mm)	Unidades por Caja Units per box
88217	7	260	● 2 200	IP44	10 000	Exterior	5 m	5050 x 10 x 7	12
88232	7	300	● 2 700	IP44	10 000	Exterior	5 m	5050 x 10 x 7	12
88234	7	300	● 6 500	IP44	10 000	Exterior	5 m	5050 x 10 x 7	12
88233	7	260	● 2 200	IP44	10 000	Exterior	25 m	25050 x 10 x 7	2
88218	7	300	● 2 700	IP44	10 000	Exterior	25 m	25050 x 10 x 7	2
88235	7	300	● 6 500	IP44	10 000	Exterior	25 m	25050 x 10 x 7	2
80017	9	550	● 2 700	IP65	6 000	Exterior	25 m	25000 x 18 x 8	2
80018	9	550	○ 4000	IP65	6 000	Exterior	25 m	25000 x 18 x 8	2

ACCESORIOS ECOFLEX 127V

Facilita tu instalación con los accesorios de ECOFLEX 127V y realiza los cortes adecuados de acuerdo a las necesidades de tu diseño de Iluminación.

Make it easy to install with ECOFLEX 127V accessories and make the appropriate cuts according to the needs of your lighting design.



80562

80563

80564

80125

80127

80128

80565

80566

80129

80130

7W/m		
Código Sku	Uso Use	Unidades por Caja Units per box
80562	Exterior	250
80563	Exterior	50
80564	Exterior	70
80565	Exterior	20
80566	Exterior	120

9W/m		
Código Sku	Uso Use	Unidades por Caja Units per box
80125	Exterior	50
80127	Exterior	15
80128	Exterior	150
80129	Exterior	100
80130	Exterior	50



TIRAS LED PRIMEFLEX 24V

Estas tiras cuentan con las características adecuadas para el mercado de proyectos profesionales enfocado a interiores y exteriores que buscan soluciones de alto rendimiento y vida útil con el fin de brindar los mayores beneficios en sistemas de iluminación general en espacios comerciales y de oficinas.

These strips have the appropriate characteristics for the professional project market focused on interiors and exteriors that seek high performance and long life solutions in order to provide the greatest benefits in general lighting systems in commercial and office spaces.



APLICACIONES / APPLICATIONS



Código Sku	Potencia/ m Power/m (W)	Flujo Luminoso Luminous Flux (lm/m)	Temp. Color Color Temp. (K)	Protección Protection	Vida Útil Life (h)	Uso Use	Dimensiones Dimensions (mm)	Unidades por Caja Units per box
80001	9.6	1170	● 2700	IP20	50 000	Interior	5000 x 10 x 1.6	10
80002	9.6	1300	○ 4000	IP20	50 000	Interior	5000 x 10 x 1.6	10
80003	12	1500	● 2700	IP20	50 000	Interior	5000 x 10 x 1.6	10
80004	12	1650	○ 4000	IP20	50 000	Interior	5000 x 10 x 1.6	10
80005	16.8	2150	● 2700	IP20	50 000	Interior	5000 x 10 x 1.6	10
80006	16.8	2350	○ 4000	IP20	50 000	Interior	5000 x 10 x 1.6	10
80007	19.2	2400	● 2700	IP20	50 000	Interior	4553 x 10 x 1.6	10
80008	19.2	2600	○ 4000	IP20	50 000	Interior	4553 x 10 x 1.6	10
80009	9.6	1200	● 2700	IP66	50 000	Exterior	5030 X 12.5 X 4.8	10
80010	9.6	1100	○ 4000	IP66	50 000	Exterior	5030 X 12.5 X 4.8	10
80011	12	1350	● 2700	IP66	50 000	Exterior	5030 X 12.5 X 4.8	10
80012	12	1500	○ 4000	IP66	50 000	Exterior	5030 X 12.5 X 4.8	10
80013	16.8	1950	● 2700	IP66	50 000	Exterior	5030 X 12.5 X 4.8	10
80014	16.8	2150	○ 4000	IP66	50 000	Exterior	5030 X 12.5 X 4.8	10
80015	19.2	2200	● 2700	IP66	50 000	Exterior	4530 X 12.5 X 4.8	10
80016	19.2	2400	○ 4000	IP66	50 000	Exterior	4530 X 12.5 X 4.8	10

DRIVERS PRIMEFLEX 24V

Complementa tus proyectos de Iluminación con tiras LED, adicionando drivers de aplicación interior o exterior que energicen adecuadamente tus tiras LED PRIMEFLEX 24V. Además cuentan con la posibilidad de integrar sistemas de atenuación 0-10V.

Complement your lighting projects with LED strips, adding drivers for interior or exterior application that adequately energize your PRIMEFLEX 24V LED strips. They also have the possibility of integrating 0-10V attenuation systems.



Código Sku	Potencia Power (W)	Parámetros de salida Output parameters		Protección Protection	Uso Use	Dimensiones Dimensions	Ideal para tiras Ideal for strips	Atenuable Dimmable	Unidades por Caja Units per box
		Tensión (V)	Corriente (A)						
80039	100	100 - 277	4.1	IP20	Interior	250 x 58 x 38	80001, 80002, 80003, 80004, 80005, 80006, 80007, 80008	No	20
80041	100	100 - 277	4.1	IP20	Interior	250 x 58 x 38	80001, 80002, 80003, 80004, 80005, 80006, 80007, 80008	0 - 10 V	20
80040	100	100 - 277	4.1	IP67	Exterior	233 x 74 x 42.2	80009, 80010, 80011, 80012, 80013, 80014, 80015, 80016	No	10
80042	100	100 - 277	4.1	IP67	Exterior	233 x 74 x 42.2	80009, 80010, 80011, 80012, 80013, 80014, 80015, 80016	0 - 10 V	10

ACCESORIOS PRIMEFLEX 24V

Aumenta las posibilidades de instalación y diversifica tus diseños integrando conectores de fácil conexión: I, L, T y X.

Increase the installation possibilities and diversify your designs by integrating easy connection connectors: I, L, T and X.

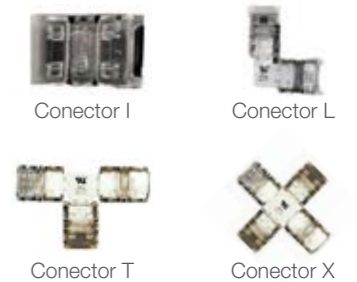

Código Sku	Descripción Description	Protección Protection	Unidades por Caja Units per box
80358	Conector I 10mm	IP20	20
80359	Conector L 10mm	IP20	20
80360	Conector T 10mm	IP20	20
80361	Conector X 10mm	IP20	20



SENSORES DE MOVIMIENTO DE USO INTERIOR Y EXTERIOR

Complementa tus equipos de iluminación adicionando sensores de movimiento, los cuales emplean ondas de radar o energía infrarroja para reconocer posibles cambios en las áreas donde se encuentran instalados. Obtén grandes ahorros de energía, esto debido a que la luz permanece encendida sólo en aquellas estancias que están ocupadas y se apaga cuando no se detecta presencia en la zona, incluso ajusta su configuración para lograrlo automáticamente al detectarse un nivel menor de luz. Olvídate de los apagadores y disfruta de estos beneficios.

Automate your lighting equipment by adding motion sensors, which use radar waves or infrared energy to recognize possible changes in the areas where they are installed. Get great energy savings, this because the light remains on only in those rooms that are occupied and turns off when no presence is detected in the area, it even adjusts its settings to achieve it automatically when a lower level of light is detected. Forget about the dampers and enjoy these benefits.



APLICACIONES / APPLICATIONS



Código Sku	Tecnología Technology	Tipo de Instalación Type of Installation	Uso Use	Protección Protection	Ángulo de Detección Detection Angle	Altura de Montaje Mounting Height	Carga Max. LED/Fluorescente (W) Maximum LED charge / Fluorescent (W) 127 V / 220 V / 277 V	Carga Max. Halógena / Incandescente (W) Maximum Halogen charge / Incandescent (W) 127 V / 220 V / 277 V	Unidades por Caja Units per box
85196	Infrarrojo	Sobreponer	Interior	IP20	360°	2.2 - 4 m	200 W / 300 W / 300 W	800 W / 1 000 W / 1 200 W	24
85197	Infrarrojo	Empotrar	Interior	IP20	360°	2.2 - 4 m	200 W / 300 W / 300 W	800 W / 1 000 W / 1 200 W	50
85198	Microondas	Empotrar	Interior	IP20	360°	2.2 - 4 m	200 W / 300 W / 300 W	800 W / 1 000 W / 1 200 W	50
85199	Microondas	Empotrar	Interior	IP20	360°	1.5 - 3.5 m	200 W / 300 W / 300 W	800 W / 1 000 W / 1 200 W	50
85200	Infrarrojo	Empotrar	Interior	IP20	120°	1 - 1.8 m	200 W / 300 W / 300 W	800 W / 1 000 W / 1 200 W	100
85202	Infrarrojo	Sobreponer	Exterior	IP44	180°	1.8 - 2.5 m	200 W / 300 W / 300 W	800 W / 1 000 W / 1 200 W	50
85203	Infrarrojo	Sobreponer	Exterior	IP44	180°	1.8 - 2.5 m	200 W / 300 W / 300 W	800 W / 1 000 W / 1 200 W	50



SENSORES DE MOVIMIENTO DE USO EXTERIOR INDUSTRIAL

Automatiza tus equipos industriales de iluminación adicionando sensores de movimiento con ondas de radar para reconocer posibles cambios en las áreas de trabajo donde se encuentran instalados. Garantiza la seguridad de los usuarios y genera grandes ahorros de energía simultáneamente, gracias a la versatilidad de este sensor podrás atenuar tus sistemas de iluminación en tres niveles: 75%, 50% y 25% en caso de no detectar presencia, por lo que podrás asegurar el correcto funcionamiento y cuidado de tus equipos, crea configuraciones personalizadas de acuerdo a las necesidades que se requieran cómodamente desde el control remoto incluido.

Automate your industrial lighting equipment by adding motion sensors with radar waves to recognize possible changes in the work areas where they are installed. It guarantees the safety of the users and generates great energy savings simultaneously, thanks to the versatility of this sensor you can dim your lighting systems in three levels: 75%, 50% and 25% in case of not detecting presence, so you can ensure the correct operation and care of your equipment, create personalized configurations according to the needs that are comfortably required from the included remote control.

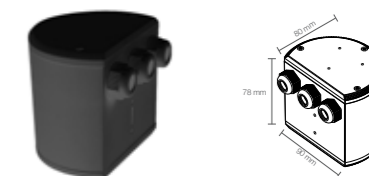
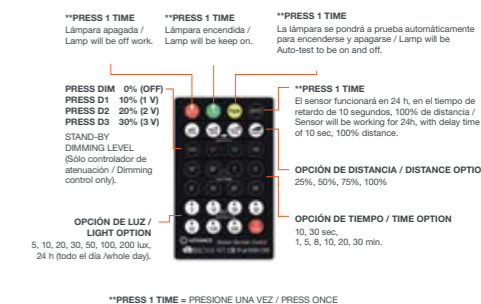

APLICACIONES / APPLICATIONS



Código Sku	Tecnología Technology	Tipo de Instalación Type of Installation	Uso Use	Protección Protection	Ángulo de detección Detection Angle	Altura de Montaje Mounting Height (m)	Atenuación Dimming	Carga máxima LED/Fluorescente (W) Maximum LED load / Fluorescent (W) 127 V / 220 V / 277 V	Carga máxima Halógena / Incandescente (W) Maximum Halogen load / Incandescent (W) 127 V / 220 V / 277 V
80447	Microondas	Sobreponer	Exterior	IP65	360°	4 - 15 m	0 - 10V	500W / 1000W / 1000W	1000W / 2000W / 2000W
								Accesorios* Accessories*	80449 Montaje para techo
								80450	Montaje tipo bisagra

* Se venden por separado / They are sold separately.



FOTOCELDA

Este accesorio permite cortar el paso de la energía eléctrica cuando hay una determinada incidencia de luz logrando realizar un control automático de encendido y/o apagado de los sistemas de iluminación con bajos costos de mantenimiento.

This accessory allows to cut the passage of electrical energy when there is a certain incidence of light, achieving an automatic control of on and / or off lighting systems with low maintenance costs.

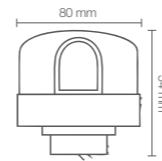

3
AÑOS DE GARANTÍA

120 - 277 V~

3
PINES

APLICACIONES / APPLICATIONS



Código Sku	Uso Use	Protección Protection	Nivel de iluminación de ambiente Light ambient	Unidades por Caja Units per box
85204	Exterior	IP44	<15 LUXES	24

SISTEMAS DE EMERGENCIA

Selecciona el sistema adecuado de acuerdo a la capacidad de los equipos de iluminación y garantiza la seguridad de los usuarios cuando exista un corte en el suministro de energía por hasta 90 minutos.

Select the appropriate system according to the capacity of the lighting equipment and guarantee the safety of users when there is a power outage for up to 90 minutes.

120 - 277 V~

90 min
RESPALDO MODO EMERGENCIA

CARGA DE BATERÍA EN 24h

Interruptor de prueba
LED indicador de carga

80023

80021

80024

80022

APLICACIONES / APPLICATIONS



Código Sku	Potencia Power (W)	Tensión de salida Output Voltage (V)	Corriente de salida Output Current (mA)	Unidades por Caja Units per box
80021	4	10 - 60 V	50 - 500 mA	30
80022	8	15 - 52 V	130 - 540 mA	24
80023	8	15 - 52 V	200 - 750 mA	15
80024	12	15 - 55 V	240 - 480 mA	15

* La iluminación en modo emergencia de la luminaria dependerá de la capacidad del driver seleccionado / The light in emergency mode of the luminaire will depend on the capacity of the selected driver.



SISTEMAS DE CONTROL INALÁMBRICO

Sistema modular inalámbrico compatible con plataformas iOS y ANDROID que permite interconectar hasta 250 dispositivos por red por medio de comunicación vía Bluetooth.

Dentro de sus principales ventajas tenemos:

Wireless modular system compatible with iOS and ANDROID platforms that allows up to 250 devices to be interconnected per network through communication via Bluetooth.

Among its main advantages we have:

Control individual o grupal	Crear escenas	Control de blanco dinámico	Control con sensor de presencia	Control con sensor de luz	Animaciones
Control ajustable de acuerdo a la luz natural	Compatible con iOS y Android	Funcionalidad de ciclo circadiano	Atenuable	Control de colores RGB	

GATEWAY BLE

Esta unidad central de control permite crear grupos de hasta 250 equipos interconectados entre si por unidad, con el fin de tener una gestión de los sistemas de control mucho más ordenadas y de acuerdo a las necesidades y requerimientos de cada espacio.

Además de ser la puerta de enlace hacia la nube donde podrá realizar cualquier configuración adicional en tiempo real.

Cuenta con dos protocolos de conexión a internet como son: Ethernet y Wi-Fi para poder ser conectado a una red local o residencial con cualquiera de éstas dos vías de comunicación.

This central control unit allows creating groups of up to 250 interconnected devices per unit, in order to have a much more orderly management of the control systems and according to the needs and requirements of each space.

In addition to being the gateway to the cloud where you can perform any additional configuration in real time.

It has two internet connection protocols such as: Ethernet and Wi-Fi to be able to be connected to a local network or residential area with either of these two communication routes.



--	--	--	--	--

Código Sku	Conectividad Connectivity	Salida de Vídeo Video Output	Sistema Operativo Operating System	Unidades por Caja Units per box
80862	Ethernet / Wi-Fi / Bluetooth	HDMI 1.3	Android	20

DRIVER BLE

Driver multi-corriente con distintas configuraciones que permite controlar hasta 50W de potencia. Ideal para luminarias que no cuentan con ningún protocolo de atenuación y que desean controlarse individualmente a través del sistema.

Multi-current driver with different configurations that allows you to control up to 50W of power. Ideal for luminaires that do not have any dimming protocol and who wish to control themselves individually through the system.



--	--	--

Código Sku	Conectividad Connectivity	Potencia Power (W)	Salida / Output parameters		Unidades por Caja Units per box
			Tensión Máxima (V~)	Corriente (A)	
80860	Bluetooth	50	60	350 - 1 200mA	50

CONTROL DE PARED BLE

Xpress es un control inalámbrico Bluetooth que se conecta al sistema de control para regular la intensidad de la iluminación, gestionar el encendido y apagado de equipos individuales, grupos y escenas previamente seleccionados en la aplicación.

Para mayor información y configuraciones consultar la ficha técnica.

Xpress is a bluetooth wireless controller that connects to the control system to regulate the intensity of the lighting, manage the on and off of individual equipment, groups and scenes previously selected in the application.

For more information and configurations consult the technical sheet.



Código Sku	Conectividad Connectivity	Alcance Range	Unidades por Caja Units per box
80861	Bluetooth	60 m	20

SENSOR BLE

Sensor infrarrojo que brinda amplios beneficios como el ahorro de energía mientras no se esté ocupando las áreas iluminadas, además de incluir un sensor de incidencia de luz con beneficios como la autorregulación de los equipos de iluminación de acuerdo a la incidencia de luz natural.

Sensor BLE provides extensive benefits such as energy savings while not occupying illuminated areas, in addition to including a light incidence sensor with benefits such as self-regulation of lighting equipment according to the incidence of natural light.



Código Sku	Conectividad Connectivity	Tecnología Technology	Tipo de Instalación Type of Installation	Uso Use	Protección Protection	Ángulo de Detección Detection Angle	Altura de Montaje Mounting Height	Unidades por Caja Units per box
80863	Bluetooth	Infrarrojo	Empotrar	Interior	IP20	53°	2.2 - 4 m	24

RELEVADORES BLE

Relevador que permite el control de cargas conectadas a este dispositivo y adiciona una comunicación 0-10V para un excelente control de equipos de iluminación.

Relay that allows the control of loads connected to this device and adds a 0-10V communication for an excellent control of lighting equipment.



Código Sku	Conectividad Connectivity	Carga Máxima Maximum Load	Salida de Control Control Output	Unidades por Caja Units per box
80865	Bluetooth	10 A	NA	25
80866	Bluetooth	2 A	0 -10V DC	25

INTERFAZ BLE

Dispositivo que emula la función de un dimmer tradicional, este dispositivo cuenta con 2 canales para protocolo 0-10V y/o 1 salida DALI, misma que puede configurarse de acuerdo a su diagrama de conexión y atenuar los dispositivos conectados a la salida de acuerdo al protocolo que sea previamente configurado dentro de la aplicación.

Device that emulates the function of a traditional, this device has 2 channels for 0-10V protocol and/or 1 DALI output, which can be configured according to its connection diagram and attenuate the devices connected to the output according to the protocol previously configured within the application.

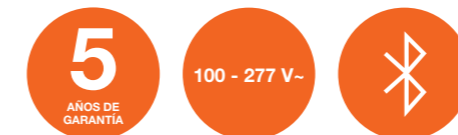

Código Sku	Conectividad Connectivity	Salida de Control Control Output	Unidades por Caja Units per box
80864	Bluetooth	0 -10V DC / DALI	100

DIMMER BLE

Dimmer Bluetooth de corte de fase para el control de lámparas incandescentes, lámparas de LED atenuables y equipos de control atenuables (transformadores de bajo voltaje y módulos de LED).

Puede atenuar cargas de hasta 75W a 120 V~ y 150W a 230 V~.

Phase cut bluetooth dimmer for controlling incandescent lamps, dimmable LED lamps and dimmable control equipment (low voltage transformers and LED modules).

It can dim loads of up to 75W at 120 V~ and 150W at 230 V~.



Código Sku	Conectividad Connectivity	Potencia Máxima Maximum Power (W)		Unidades por Caja Units per box
		120V~	230V~	
80950	Bluetooth	75W	150W	160

CONTROLADOR DE TIRAS LED RGBW BLE

Controlable por Bluetooth para cargas LED de voltaje constante, tales como: tiras LED y módulos LED de voltaje constante, lo que lo convierte en un aliado ideal para aplicaciones RGBW y blanco dinámico (TW).

Bluetooth controllable for constant voltage LED loads, such as: constant voltage LED strips and LED modules, making it an ideal ally for RGBW and Tunable White (TW) applications.



Código Sku	Conectividad Connectivity	Potencia Máxima Maximum Power (W)		Unidades por Caja Units per box
		12V	24V	
80867	Bluetooth	72W	144W	120

ACERCA DE LEDVANCE

Con oficinas en más de 50 países y actividades comerciales en más de 140 países, LEDVANCE es uno de los principales proveedores de iluminación general del mundo para usuarios profesionales y consumidores finales. Tras emerger del negocio de iluminación general de OSRAM GmbH, LEDVANCE ofrece una amplia gama de luminarias LED para una gran variedad de usos en áreas de aplicación, productos de iluminación inteligente para hogares y edificios inteligentes, una de las carteras de lámparas LED más grandes de la industria, así como también fuentes de luz tradicionales.



LEDVANCE, S.A. DE C.V.
Camino a Tepalcapa No.8
Col. San Martín Tultitlán,
Tultitlán, Estado de México, México, CP 54900
01 800 716 7007 (interior de la República)
5899 1807 (CDMX y Área Metropolitana)

Síguenos en redes sociales @ledvancemexico

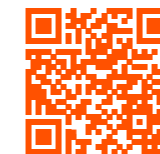

Licencia de producto de marca OSRAM para lámparas en iluminación general